

Yale University

EliScholar – A Digital Platform for Scholarly Publishing at Yale

Cowles Foundation Discussion Papers

Cowles Foundation

1-1-1977

Strategies for the Control of Carbon Dioxide

William D. Nordhaus

Follow this and additional works at: <https://elischolar.library.yale.edu/cowles-discussion-paper-series>



Part of the [Economics Commons](#)

Recommended Citation

Nordhaus, William D., "Strategies for the Control of Carbon Dioxide" (1977). *Cowles Foundation Discussion Papers*. 675.

<https://elischolar.library.yale.edu/cowles-discussion-paper-series/675>

This Discussion Paper is brought to you for free and open access by the Cowles Foundation at EliScholar – A Digital Platform for Scholarly Publishing at Yale. It has been accepted for inclusion in Cowles Foundation Discussion Papers by an authorized administrator of EliScholar – A Digital Platform for Scholarly Publishing at Yale. For more information, please contact elischolar@yale.edu.

COWLES FOUNDATION FOR RESEARCH IN ECONOMICS

AT YALE UNIVERSITY

Box 2125, Yale Station
New Haven, Connecticut 06520

COWLES FOUNDATION DISCUSSION PAPER NO. 443

Note: Cowles Foundation Discussion Papers are preliminary materials circulated to stimulate discussion and critical comment. Requests for single copies of a paper will be filled by the Cowles Foundation within the limits of the supply. References in publications to discussion papers (other than mere acknowledgement by a writer that he has access to such unpublished material) should be cleared with the author to protect the tentative character of these papers.

STRATEGIES FOR THE CONTROL OF CARBON DIOXIDE

William D. Nordhaus

January 6, 1977

STRATEGIES FOR THE CONTROL OF CARBON DIOXIDE*

by

William D. Nordhaus

I. Climatic Effects of Energy Use

In recent years, the concerns about the tradeoffs between economic growth and environmental quality have been paramount. To a large extent, the energy sector has been the locus of the major battles. For the most part, the concerns have been with local environmental problems such as disputes over air and water quality, large-scale accidental releases of radioactive material, and long-term storage of radioactive wastes. Although these problems have not been solved, it appears that as a result of a considerable scientific and engineering effort that techniques exist (even if political will does not) to reduce most local environmental problems to a tolerable level.

There remain on the agenda, however, a number of global environmental problems, and again these relate mainly to the energy sector.¹

*This work was performed with the support of the United States National Science Foundation, the International Institute for Applied Systems Analysis, Laxenburg, Austria, and the Cowles Foundation at Yale University. Discussions with Cesare Marchetti and Alan Murphy helped me find my way in the climatic literature, while Leo Schrattenholzer skillfully programmed the model. An earlier version of this paper appears as Nordhaus [1975]. None of the above are responsible for errors or opinions expressed in the paper.

¹See especially Matthews et al. [1971], Kellogg and Schneider [1974], and Schneider [1976].

More specifically, it appears that emissions of carbon dioxide, particulate matter, and industrial heat may, at some time in the future, lead to significant climatic modifications.

Energy and Climate

When we refer to climate, we usually are thinking of the average of characteristics of the atmosphere at different points of the earth, including the variances such as the diurnal and annual cycle. The important characteristics for man's activities are temperature, precipitation, snow cover, winds and so forth. A more precise representation of the climate would be as a dynamic, stochastic system of equations. The probability distributions of the atmospheric characteristics is what we mean by climate, while a particular realization of that stochastic process is what we call the weather.

Recent evidence indicates that, even after several millenia, the dynamic processes which determine climate have not attained a stable equilibrium. One of the more carefully documented examples is the global mean temperature which over the last 100 years has shown a range of variation of five-year averages of about 0.6°C (see Figure 1). The disputes about the sources of such variations are reminiscent of business cycle theory--with theories mentioning everything from sunspots to quasi-periodic oscillations to the existence of many locally stable but globally unstable equilibria.

The overall observation of high amounts of "red noise"--as is also the case for typical economic time series¹--has important implications

¹ See Granger [1966].

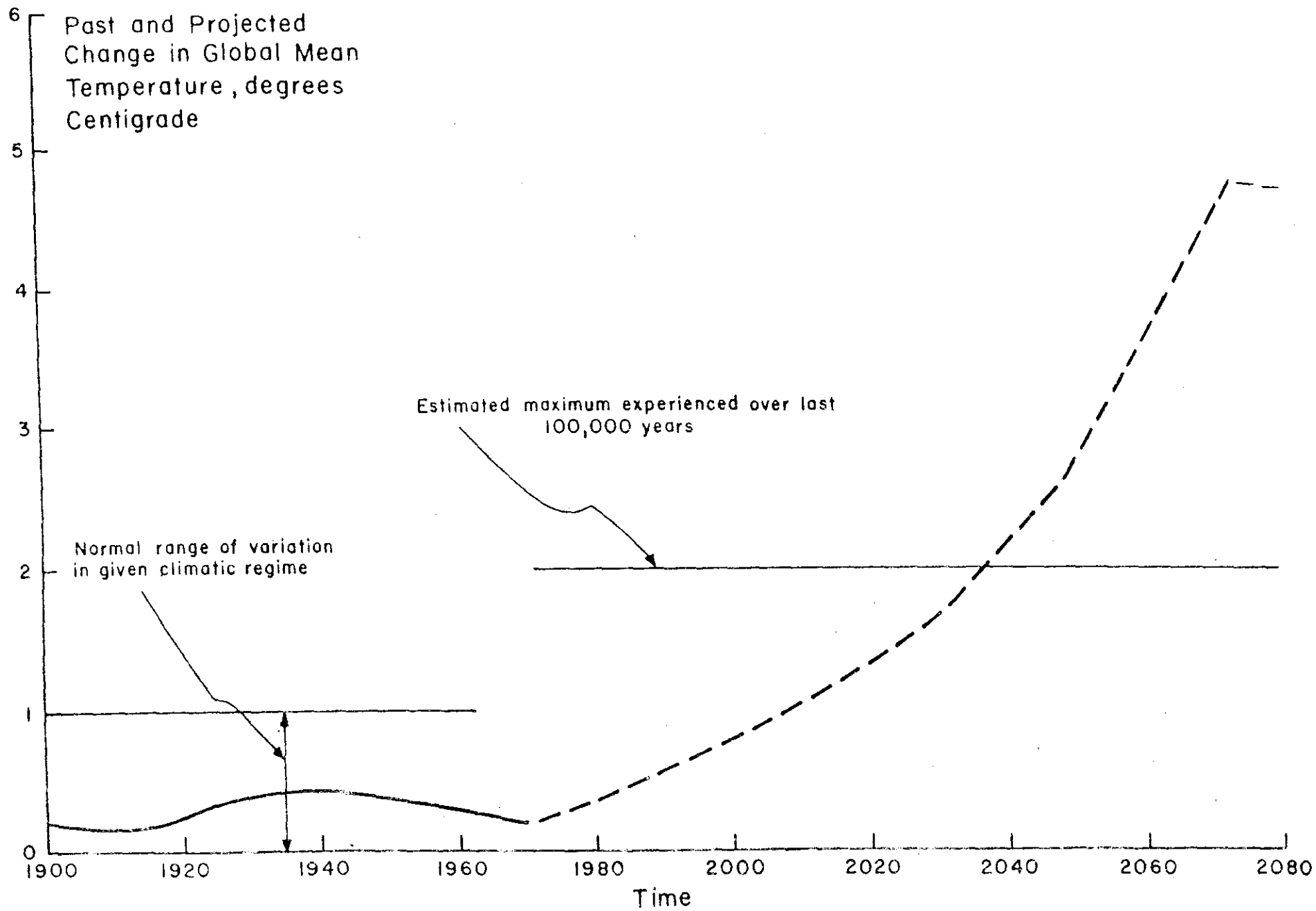

Figure 1. Past and projected global mean temperature, relative to 1880-84 mean. Solid curve up to 1970 is actual temperature. Broken curve from 1970 on is projection using 1970 actual as a base and adding the estimated increase due to uncontrolled buildup of atmospheric carbon dioxide.

for those who are concerned with climatic implications of man's behavior. This implies that the climatic stability we generally assume should not be taken for granted; indeed, some have pointed out that the string of recent good harvests in the midwestern U.S. is no more likely than Dust Bowls of the 1930s.¹ Moreover, given the slowly changing climatic patterns it is difficult to separate nature's red noise from the red signal due to man's smoothly growing economic behavior.

At what point is there likely to be a significant² effect of man's activities on the climate? Many climatologists feel that the changes witnessed in the last century--the 0.6°C range--have led to major, albeit not catastrophic results. It should be stressed that the changes in temperature are rather trivial; it is not the mean temperature change which is economically significant, but other variables such as degree-days, precipitation, and snow cover, and these tend to vary much more than global mean temperature. Examples of high amplification are changes in precipitation and changes in the latitude of monsoons with changes in temperature. (See Machta and Telegados [1974] or Schneider [1976].) For example, Bryson [1974] has studied the effect of temperature on tropical monsoons. From theoretical analysis Bryson predicts that very small changes in temperature shift the latitude of the tropical monsoon south by a sizable distance--enough to cause draughts such as that in the Sahel. Given the amplification, it seems prudent to consider a change of 0.5°C as a significant change.

Therefore if we define a significant change arbitrarily as a 0.5°C change in global mean temperature, the estimated time at which such a level is reached is as follows: For carbon dioxide such a change would

¹See Schneider [1976], Chapter 3.

²"Significant" in the economic, not the statistical sense.

come with about a 20% increase in atmospheric concentrations. According to recent models, this will come about 1990.¹ For industrial heat (sometimes called "waste heat"), the estimates are less secure. Using the same methodology as for the carbon dioxide estimates, it is estimated that industrial heat will lead to an increase of 0.5°C around 2060.² For particulate matter, the matter is even more problematical. Rasool and Schneider [1971] indicate that increasing the suspended particulate matter by a factor of 4 would lower the mean temperature of the surface by 3.5°C, but the current evidence points toward particulates warming rather than cooling (see Matthews et al. [1971], Chapters 22 to 30, especially 22 and Kellogg et al. [1975]). On this question, however, natural contributions still constitute 95 percent of particulates, and agriculture is likely to dominate the energy sector as a contributor. In fact, it appears that particulate emissions from the energy sector in the U.S. have actually been decreasing.³

¹The estimates of carbon dioxide concentration are from Baes et al. [1976] and are consistent with our estimates in Section VI below. The temperature response is from Manabe and Wetherald [1969]. The more recent estimate in Manabe and Wetherald [1975] which is 50% larger than their earlier estimate, is not used because this includes the full ice-albedo feedback (including land-based ice) which can hardly be expected within 50 years.

²Interpolating from Manabe and Wetherald [1967], the effect of an increase of the solar constant of 0.2% is to increase global mean temperature by 0.5°C. (The later study [1975a] by the two authors is not used for the reason given in the last footnote.) Further assume that an increase in the solar radiation reaching the outer limits of the earth's atmosphere amounting to 1 percent is equivalent to an increase of $(1-\alpha)$ in man's production of heat, where α is the albedo (reflectivity) of the earth and that the rate of growth of energy consumption is 4 percent annually.

³The calculation for particulates is subject to greater uncertainty than that for carbon dioxide or man-made heat. Particulate emissions are heavily dependent on technology and environmental policy. Further, the residence time in the atmosphere varies from a few hours in the lower troposphere to several years in the upper stratosphere. Finally, the effect on temperature depends on the vertical distribution, albedo, and cloudiness; most

In summary, present knowledge indicates that carbon dioxide will be the first man-made emission to affect climate on a global scale, with a significant temperature increase within 20 years. We will therefore concentrate in the present paper only on carbon dioxide.

A brief overview of the problem is as follows: combustion of fossil fuels leads to emissions of carbon dioxide into the atmosphere. The emissions slowly distribute themselves by natural processes into the oceans, into the biosphere, and, eventually, into fossils. Although this exact process is not completely understood, it is clear that the residence time of carbon dioxide in the atmosphere is extremely long, and that at the present approximately half of the industrial carbon dioxide remains in the atmosphere. The ultimate distribution of carbon dioxide between the atmosphere and the other sinks is not known, but estimates of the man-made or industrial carbon dioxide asymptotically remaining in the atmosphere range between about two and fifty percent.¹

It is generally thought that there are two important effects of the atmospheric buildup of carbon dioxide. First, there may be a highly beneficial effect of increased concentration on agriculture, since higher concentrations lead to higher rates of photosynthesis.² The second

kinds of stratospheric dust tends to cool, while low level dust--like soot from Florida smudge pots--tends to warm. (See Herman and Browning [1975] or Shotkin, Ludewig, and Thompson [1975].) In any case, mechanical exercises extrapolating growth of particulates at the rate of growth of energy consumption lead to the conclusion that particulates would have the significant 0.5°C effect by about 2060.

¹ See Matthews *et al.* [1971], Machta [1972], Keeling [1973], NCAR [1975], Baes *et al.* [1976] and MacIntyre [1970].

² For a further discussion, see below, pp. 31 ff.

effect is on the climate through the "greenhouse" effect. Because of the selective absorption of radiation, the increased carbon dioxide concentration leads to an increase in the surface temperature of the earth. Table 1 lists a number of recent studies. The studies give a range of estimates from 0.7°C to 9.6°C . The Manabe-Wetherald [1975] estimate is the most complete for long-run purposes in that it is a three dimension general circulation model, with the feedback effects between temperature and snow-ice-albedo; when discussing long-run effects we will therefore consider primarily the Manabe-Wetherald [1975] in the present discussion. For the short-run (up to 100 years), the early Manabe-Wetherald [1967] is more appropriate in that it includes no ice-albedo feedback.¹

¹The assumption about the length of time for the response of the entire ice-albedo feedback was criticized in a prior draft of the paper. Recall that we are assuming that, because the response of land-borne ice is extremely slow, a fair part of the ice-albedo feedback effect should be omitted for the present analysis. Although we do not know what difference this omission would make to the 1975 Manabe-Wetherald estimate, it was hypothesized that the increase in responsiveness of the global temperature to the carbon dioxide concentrations without the ice-albedo feedback would be that estimated in the 1967 study.

It was noted by the critic that although the bulk of the volume of ice was in land-borne ice, the same was not true for area. According to Untersteiner [1975], p. 202, the area of land ice is approximately 17 million square km, while the area of sea ice varies between 17 and 28 million square km. In the months of sunshine, then, the extent of sea ice is perhaps 55 percent of the total area of high-albedo regions. The effect on albedo would probably be less, however, since the albedo of sea-borne ice is considerably lower than that of land ice (see Bućyko [1974]). There seems little reason to speculate further on this question, except to say that the 2°C effect of doubling CO_2 concentration may be slightly low as a short-run estimate for the 1975 Manabe-Wetherald model structure.

In any case, it should be noted that none of the actual figures here, only their interpretation, depends on this estimate: the actual computations are decoupled from the estimate of the temperature responsiveness. If, in fact, the estimate of responsiveness is too low, the figures on temperature and sea level response in part VI should be revised accordingly.

Figure 2 shows the long-run effect of CO₂ doubling on surface temperature by latitude. The effect on surface temperature is generally around 2°C up to about 40° latitude (roughly New York), then increases dramatically, to 4½ degrees at 60°, up to over 10°C in the polar regions. (Sellers' [1974] shows the same differential effect by latitude.) Judging by the difference of temperatures in two standard runs (Manabe-Wetherald [1975], p. 15) temperature differences above 1°C are statistically significant. Figure 3 shows estimates of precipitation rates. The general effect is to increase precipitation in latitudes above 40°, and mixed below 40°. There are predicted precipitation decreases in the 30-40° belt and in the desert regions (10-20°).

Beyond the results on temperature which are agreed on (at least to the order of magnitude shown in Table 1), several authors paint dark pictures of the climatic response to the warming trend. One of the more detailed pictures is that of the noted Soviet climatologist M. I. Budyko (see [1977] and [1974]). His studies indicate that the most sensitive

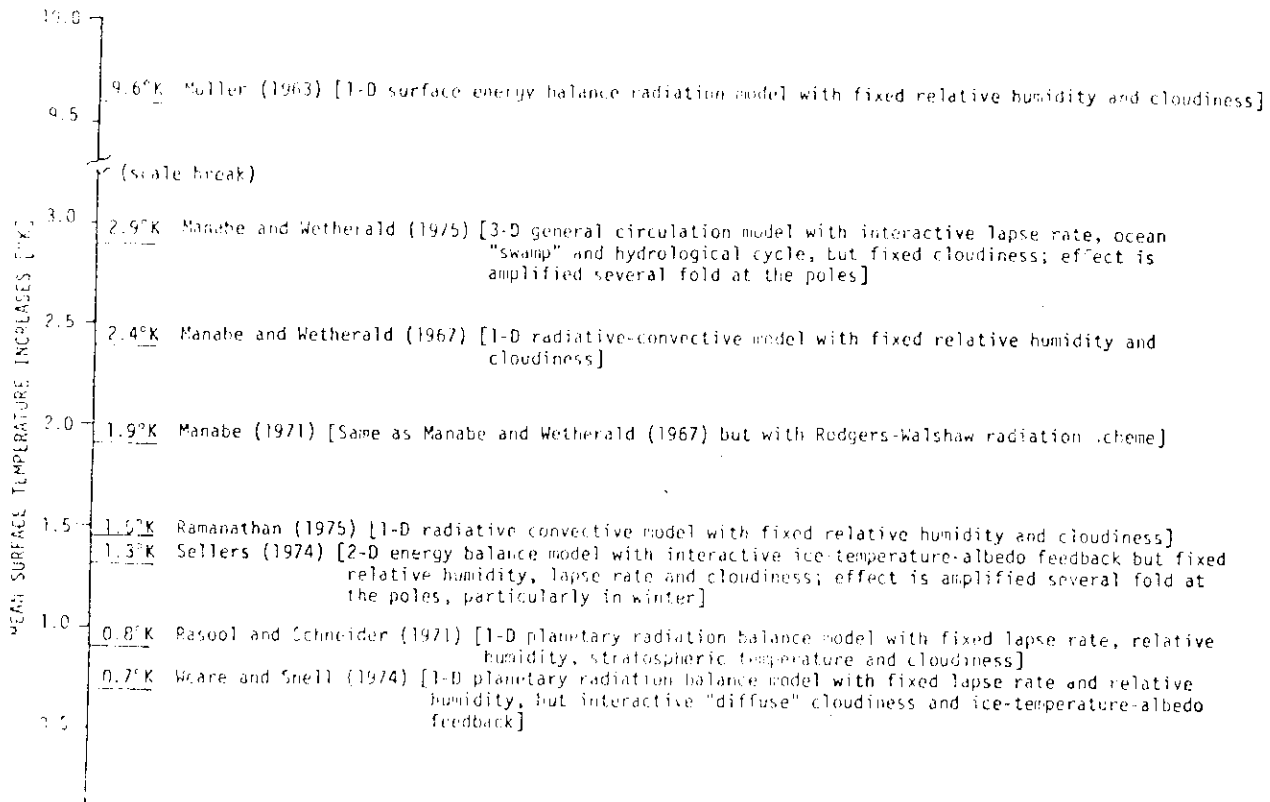

Table 1. Estimated response of mean surface temperature for doubling of atmospheric carbon dioxide, various models, from Schneider [1975]. Schneider suggests that a state-of-the-art order-of-magnitude estimate is a change between 1.5° and 3° C, but that combined effects of improperly modeled feedbacks could enhance or reduce this order-of-magnitude estimate by as much as a factor of 4.

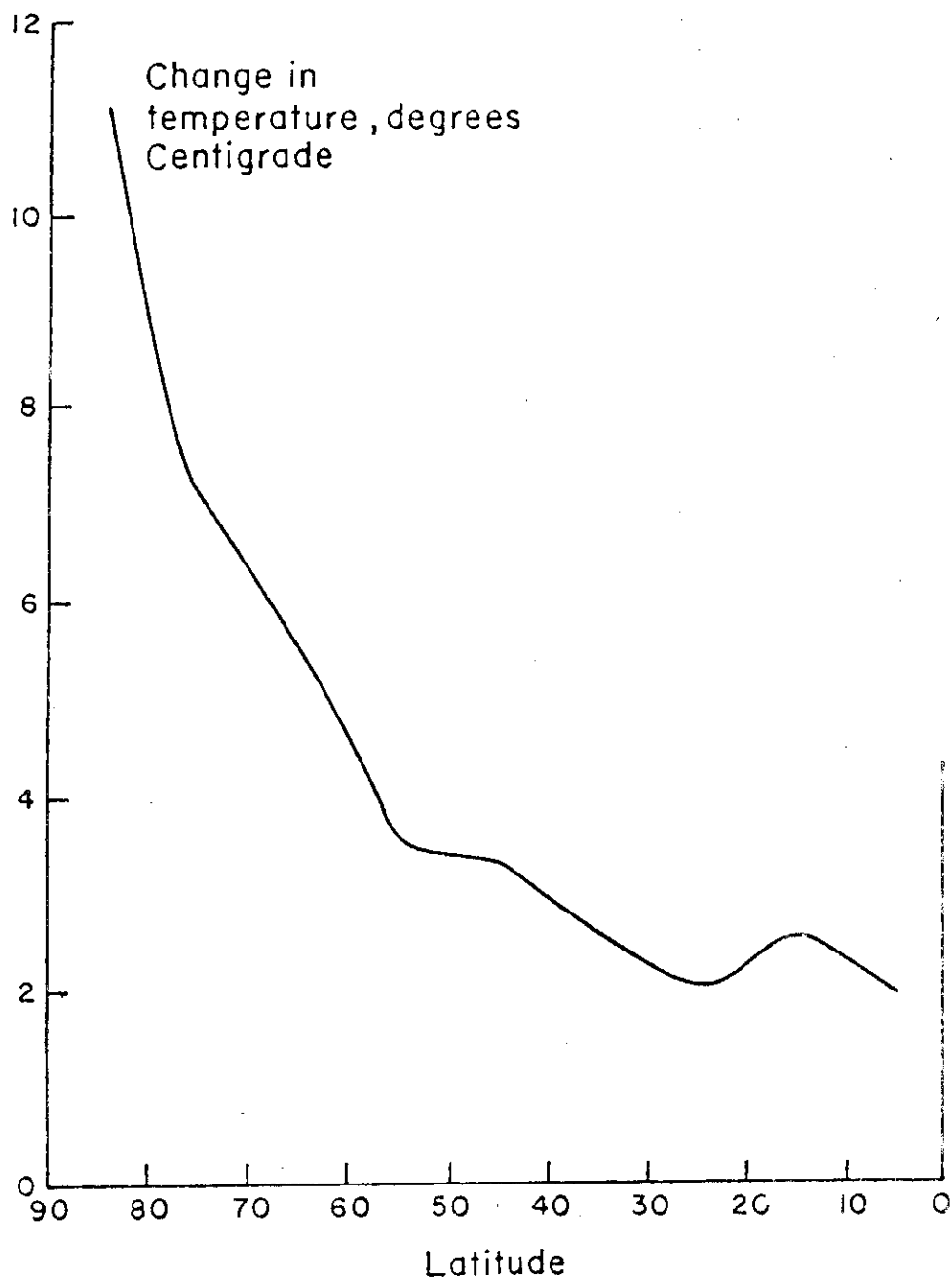

Figure 2. Estimated effect of doubling of atmospheric carbon dioxide on surface temperatures, by latitude. From Manabe and Wetherald [1975].

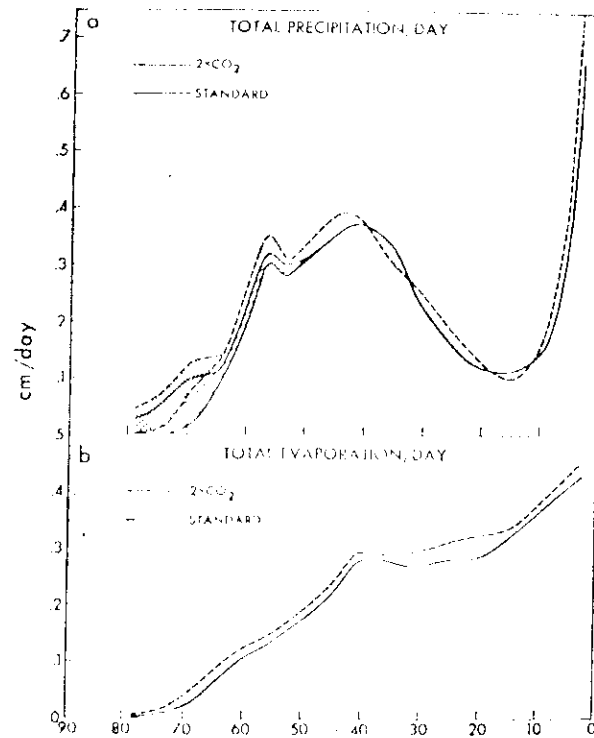

Figure 3. Mean rates of precipitation and evaporation, by latitude, for standard case and for doubling of atmospheric carbon dioxide. Shaded areas in top figure indicate rates of snowfall. From Manabe and Wetherald [1975].

point in the earth's climatic equilibrium is the floating Arctic ice pack. This varies from 2 to 3 meters in thickness, and is quite sensitive to minor temperature fluctuations. Consequently, again according to Budyko, a summer temperature increase of 4°C would lead to the melting of the floating Arctic ice pack within a decade.¹ From Figure 2, we see that temperature increase from doubling CO_2 is well beyond 4°C . If Budyko is correct, it is highly probable then, that the permanent Arctic ice pack will disappear well before the time CO_2 doubling occurs.²

By itself, an open Arctic ocean would lead to rather dramatic changes in the climate of the Northern hemisphere. Studies by Newson [1973], and Warshaw and Rapp [1972] attempt to resolve more finely the effects. Figure 4 from Newson shows the results of a general circulation model with an open Arctic ocean; it suggests that it is possible that even though the climate as a whole is warmed, a cooling of continental climates may occur because of weakened westerlies. Note that the middle United States shows a cooling of 8°C . It would be even more useful to examine precipitation patterns for an open Arctic ocean, but no published studies have been uncovered.

It is crucial to separate the floating Arctic ice from the land-based ice. Melting of sea-ice has no effect on sea level, while a rapid melting of the massive ice caps of Greenland and Antarctica would be a

¹Untersteiner [1975] presents further evidence which suggests Budyko's studies overstate Arctic ice sensitivity.

²It should be noted that studies of Manabe and Wetherald [1975] do not indicate melting of polar ice in the CO_2 doubling, but these simulations misspecify certain crucial geological features (for example assuming that above 70° of latitude the earth is assumed to be land rather than sea) and contain no seasonal features.

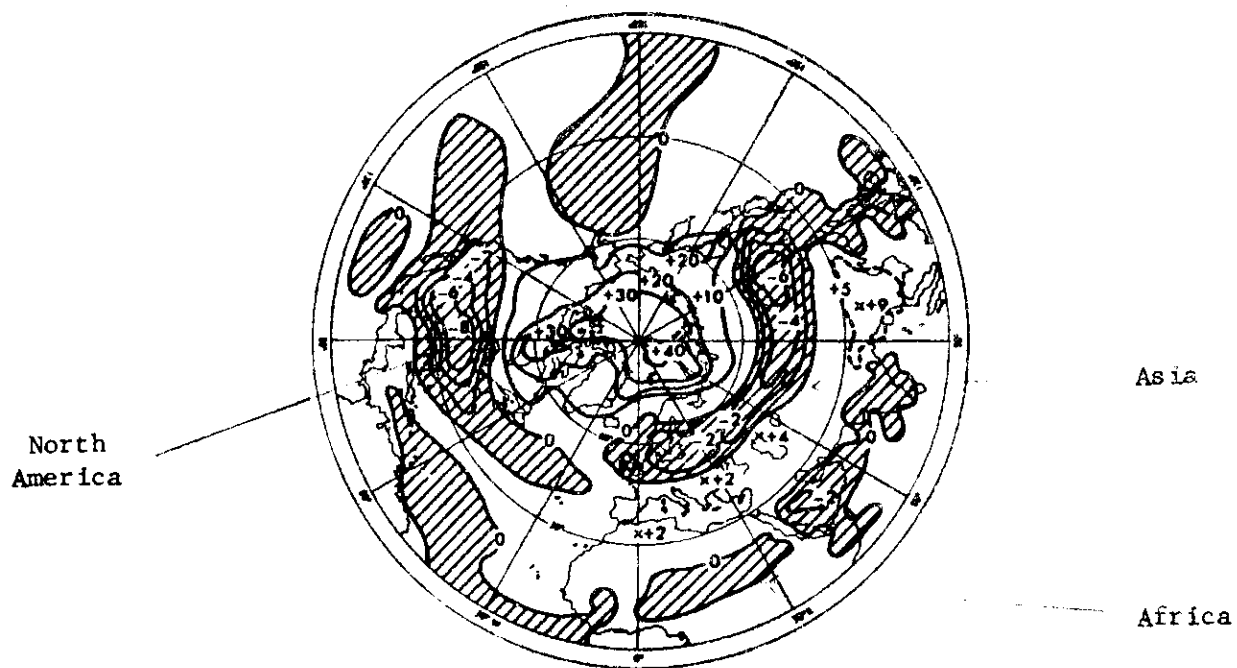

Figure 4. Calculated difference in surface temperature between ice-free arctic ocean and ice at the mean climatological position. Center of diagram is North Pole. Hatched areas indicate regions of cooling in ice-free experiment. Figures in map show estimated change in temperature between ice-free and ice-borne runs, degrees C. From Newson [1973].

major catastrophe, for the ice caps contain enough water to raise the sea level by 90 meters (300 feet). Past evidence indicates, however, that any melting will proceed extremely slowly. In previous warm periods, the period over which glacial retreat occurred was in the order of 5000 years. Further, it is suspected that the Antarctic ice pack (which contains about 80 percent of land-based ice) has grown during warm periods. Most important is the fact that the temperature at the top of the Antarctic ice packs--1700 meters (5600 feet) above sea level--ranges from -60°C to -30°C , and warming of even 10°C would leave the temperature well below freezing.¹

Long-run equilibrium models like Manabe-Wetherald [1975] mask much of the dynamics of climate change. At present, there are no generally accepted models which show the dynamics of the response of land-borne ice to future temperature changes. As a result it is difficult to judge what fraction of the predicted climatic effects will occur within the next 150 years. Given the criticality of the response of the oceans to temperature, we have attempted in the Appendix to obtain very crude estimates of the relationship. The data for the last 15,000 years indicates that a 1°C increase in temperature would lead to an asymptotic increase in the level of the oceans of between 5 and 10 meters. On the other hand, the response appears to be extremely slow, with the time period for one-half the rise being in order of 1500 to 3000 years. We thus estimate² that the order of magnitude rise of oceans is 2.4 millimeters per year per degree C. Note that currently the oceans are rising about 1 mm. per year.

¹The statements in the preceding paragraph are largely based on Lamb [1972] and Understand Climate Change [1975].

²This estimate is extremely crude and is derived by comparing estimates of the sea level changes and temperature levels over the last 15,000 years. See Appendix.

Using these estimates, we can make a rough projection of the rise in sea level over the next century or so. Along the estimated uncontrolled path, the cumulative rise predicted on the two assumptions would be about 0.1 meters by 2000, 0.3 meters by 2050, and 0.8 meters by 2100 (see Section VI.3 for further discussion). Per se, changes of this magnitude and at this speed are not catastrophic, although they would eventually cause hardship in low-lying areas. The major danger is not the more-or-less predictable rise which would accompany the warming trend, but less predictable events such as Antarctic ice surges.

In light of the many studies which suggest that we are on the brink of a new ice age, mention of the possibility of cooling should be made. In Understanding Climatic Change [1975], Appendix A (also see Kutzback and Bryson [1975]) the Panel on Climatic Variation of the National Academy of Sciences reviewed a number of spectral analyses of past climatological data; these were presented in order to determine if there are statistically significant cycles for periods from 1 to 100,000 years. They found no statistically significant cycles between 1 and 10,000 years at the 99 percent significance level, although there were many ominous looking wiggles, for example at 35, 75 and 1,750 years. Nevertheless, the Panel estimated what the trend of climatic fluctuations would be if the past data were produced by regular sinusoidal fluctuations (see Table A.3 in this reference). According to this estimate, the rate of temperature change at the present (the decade of the 1970's) is $-.0154^{\circ}\text{C}$ per year. This relatively steep (if, again, statistically insignificant) rate of change is, however, ephemeral, and according to the same source will be reversed in about 20 years. The Panel concludes as follows regarding the likelihood of a major change in climate (excluding anthropogenic changes) over the next 100 years: "The [results] indicate that the probability of one transition of climate (in either direction)...that is normally associated with climatic fluctu-

ations on the time scale of 100 years (a change of up to perhaps 0.5°C in a total time interval of about 50 years or less)...is indicated to have a probability of about 0.02 of occurring in the next year, a probability of about 0.16 of occurring in the next 10 years, and a probability of about 0.35 of occurring in the next 50 years," p. 188. Concerning the possibility of an end to the present interglacial period, a temperature change in the order of -2°C , they find that if the transitions are strictly random (Poisson distributed) the probability of such a change in the next 100 years is about 5 in 100. They write, "If the end of the interglacial is episodic in character, we are moving toward a rather sudden climatic change of unknown timing, although as each 100 years passes, we have perhaps a 5 percent greater chance of encountering its onset. If, on the other hand, these changes are more sinusoidal in character, then the climate should decline gradually over a period of thousands of years" (p. 189). In summary, if we assume climate is cyclical, then the predicted descent into a significant cooling period will be at a pace so slow that anthropogenic sources are likely to swamp it. On the other hand, if the descent is episodic, then the probability of a temperature decrease large enough to offset the increase predicted to occur from anthropogenic causes is very small.

The Carbon Cycle

The carbon cycle is shown schematically in Figure 5. There are five sets of state variables: (I) the activities or sources of carbon dioxide; (II) the concentrations in the first reservoir for the carbon dioxide emissions; (III) the concentrations in the ultimate reservoir for the emissions; (IV) the proximate effects of the increased output of carbon dioxide; and (V) the ultimate effects on man and other important

variables. There are four functional relationships relating the different state variables: (a) the emission equations relate the emissions of carbon dioxide to activity levels at the sources; (b) the diffusion equations indicate how the initial emissions of carbon dioxide are diffused among the various ultimate reservoirs; (c) the climatic effects indicate how the important climatic variables relate to the concentrations of carbon dioxide in the different reservoirs; and (d) finally relations show the effects of climatic and other variables upon the significant variables for man. Of course each variable has a time dimension indicating its time path.

There are major uncertainties at each stage of the cycle, and the major uncertainties in the cycle are indicated by the placement of the question marks in Figure 5, with larger question marks indicating greater uncertainty. Roughly speaking, the further down the cycle, the larger are the uncertainties about the functional relations and the larger are the uncertainties about what variables will be affected. This is especially so for the effects on climate (IV) and ultimate effects (V).

Strategies for Control

The outcome just described is the effect of an uncontrolled economy-climate system, that is one in which the economy, the energy system, the emissions of carbon dioxide, and the climatic response evolve simply on the basis of economic forces, without taking into account the effect of the energy system through carbon dioxide onto climate and man.

The problem is a classical economic example of market failure--the problem of external economies, or externality for short. An externality arises when economic agents do not pay for the entire social cost

FIGURE 5

The Carbon Dioxide Cycle

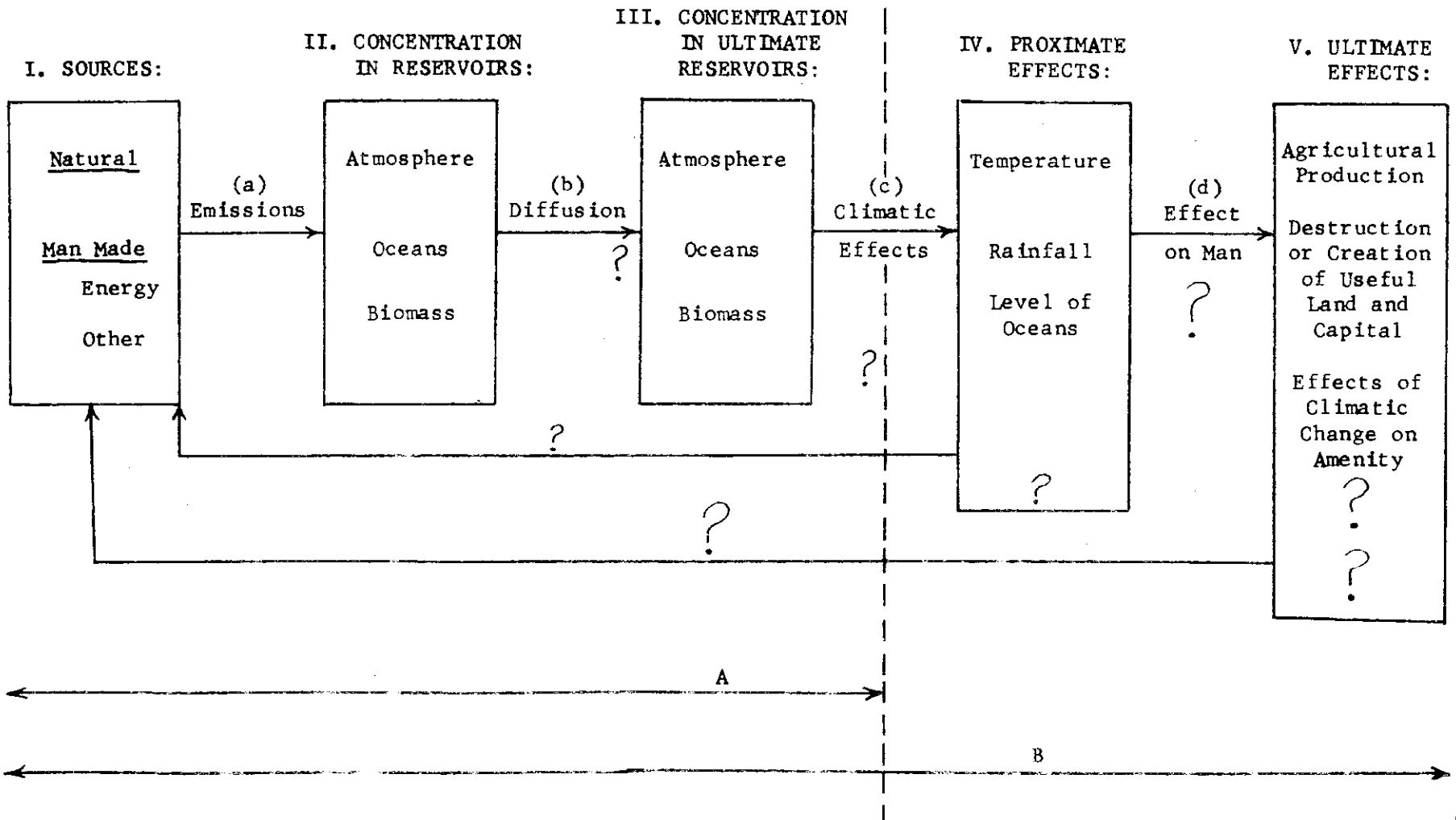

of their activities. Thus when a steel mill spews out soot which blackens the neighborhood, the owners of the mill pay for labor and capital they use but not for the higher laundry bills which are caused by the dirty air. From a private point of view clean air has a zero price to the steel factory, and being so cheap, it is natural that cost-conscious managers will substitute cheap air for expensive labor and capital. From a social point of view the result is too much steel and dirty air, too little pollution abatement.

The problem of external economies has a long history in economics, with the first modern discussion in Pigou [1960], and a rigorous analysis in Samuelson [1954]. More recently, the problem has been viewed as a systems problem in Hardin's "Tragedy of the Commons" [1960]. The common theme of all these works is that the externalities in an economic system lead to misallocation, sometimes catastrophe.

In analyzing the effect of man's impact on climate we are faced with a pure example of an externality. When an individual burns gasoline in his car, or oil in his furnace, he pays for the capital equipment in the furnace and for the fuels. He pays nothing for his carbon dioxide emissions or the effect of his activities on the climate. Even if he is an altruist, he would have to recognize that his contribution to solving the long-run climate problem is negligible. For producers, it is even more difficult to take the externality into his decision: a producer who tried to reduce his climatic impact in a competitive industry would rapidly find that good guys finish last, or not at all; that is he would not be able to survive in a competitive industry of socially unconscious profit-maximizing entrepreneurs.

The control strategy for carbon dioxide thus involves two aspects.

On a scientific and aggregate level, the feasibility of controls and control techniques must be explored. But there must also be a way of decentralizing the control (of internalizing the externality) so that individual producers and consumers have proper incentives to implement the control strategy on an individual level. We now consider briefly these two aspects.

Figure 6 gives an overview of the model used to investigate strategies. The block labelled "energy system" can be viewed as the current system of mixed market and political mechanisms. The driving variables are energy resources, incomes, and population. The interaction of the supply and demand forces leads to a path of prices and consumption over time. Such a model was used in Nordhaus [1973] to estimate the efficient allocation of energy resources as well as the behavior of a competitive market for energy.

In the presence of externalities, such as the carbon dioxide cycle analyzed here, we must take into account the emissions and distribution of the pollutant shown in Figure 4 above. This step leads us to impose standards on atmospheric concentrations, as on the right hand side of Figure 6. By imposing standards we close the loop and force the energy system to shift the composition of supply and demand.

Outside the entire system there is yet another box, indicating that the entire system is being optimized. Thus the levels of the energy system and climatic variables are chosen, subject to the relevant constraints, so as to optimize the path of the system as a whole.

There are three general approaches to the problem of keeping atmospheric concentrations to a reasonable level, illustrated in Table 2.

Figure 6. Overview of Model Optimizing the Energy-Environment System

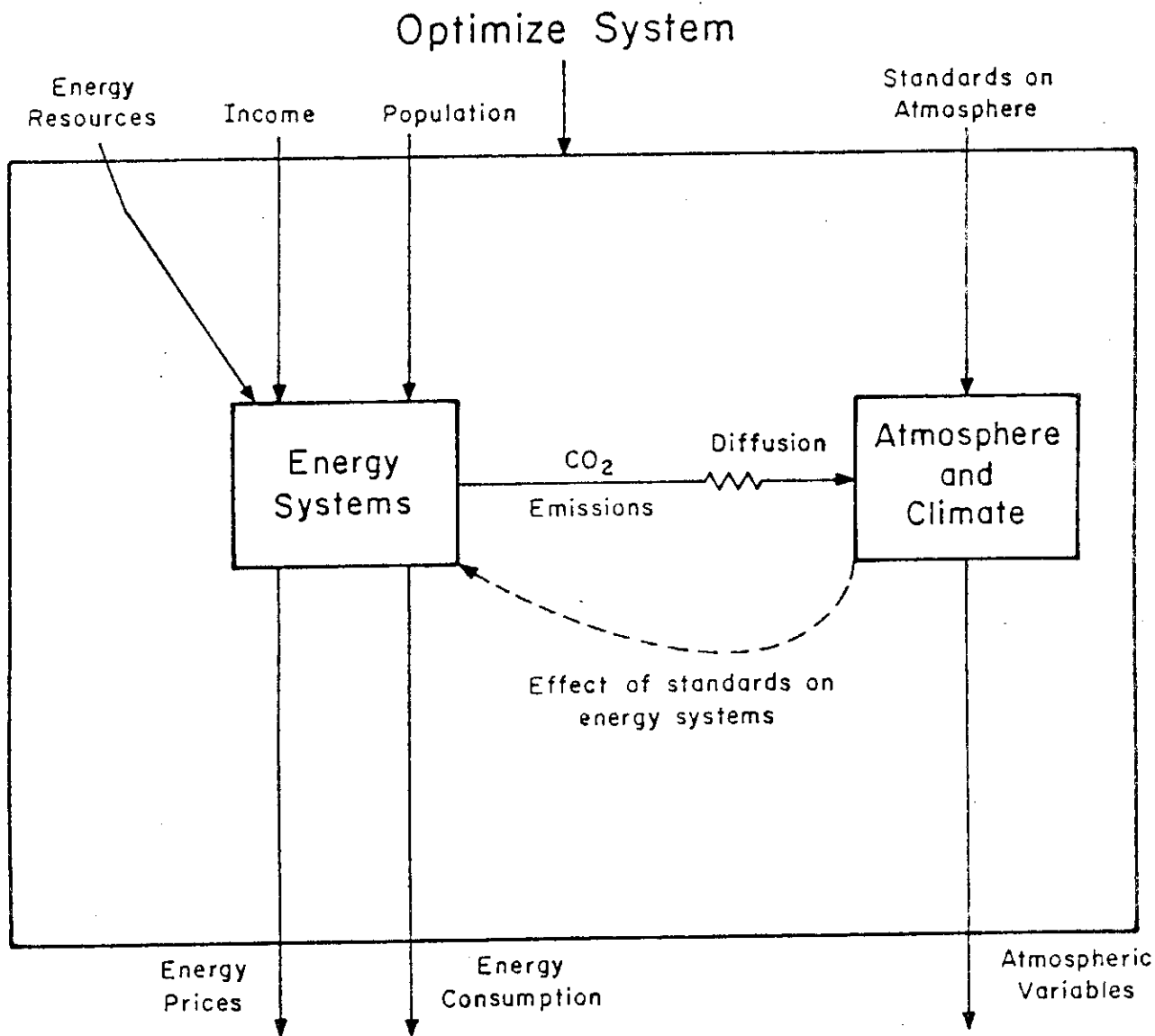

TABLE 2
Control Strategies

- I. Nature's way and pray: do nothing
- II. Reduce energy consumption*
- III. Reduce atmospheric concentrations
 1. Reduce emissions by substitution in supply*
 2. Offset effects
 - a. Mix into oceans
 - b. Other counteracting policies (particulates, paint, band-aids)
 3. Clean up ex post
 - a. Remove from air
 - b. Grow and "pickle" trees

Note: Asterisked strategies (*) are considered in model. All are discussed briefly in text.

At the top of the list (in likelihood if not desirability) is the approach of doing nothing. This consists of simply letting the market forces provide the solution, with the price of climatic change and disruption implicitly set at zero. The other strategies are active in that they attempt to reduce atmospheric concentrations to a "tolerable" level. In general, the strategies can either reduce energy consumption, or reduce atmospheric concentrations while keeping demand the same, or some combination of the two. If concentrations were linked to energy consumption by an iron law, the only way to keep climatic effects to a tolerable level would be to reduce consumption. In fact, as we will see, inhomogeneities in nature and substitute technologies allow a very large reduction in atmospheric concentrations without drastically affecting energy consumption. Put differently, the climatic effects are a function of the atmospheric concentrations of carbon dioxide, while the economic desideratum (either as an end in itself or, more generally, as an input to economic processes) is energy consumption, and there is no iron law linking energy consumption and atmospheric concentration together in an inexorable relation.

In the category of reducing atmospheric concentrations there are three possibilities. The first strategy, which is the route chosen in the present paper, is to reduce emissions of carbon dioxide. This takes place by substituting non-carbon-based fuels for carbon-based fuels.

The second strategy is to offset the effects of emissions of carbon dioxide. This can take the form of introducing the carbon into places where its climatic effect is nullified or delayed, or of using counter-acting forces to offset the effects. For example, if CO_2 is compressed and pumped into the oceans at a depth of at least 2000 meters, it would be at a specific gravity heavier than water and would therefore tend to

remain at great depths until molecular or eddy diffusion raised it to the mixed layer--probably only after thousands of years. Suggestions which have been made are to introduce stratospheric dust to cool the earth, changing the earth's albedo by putting gauze (hence "band-aids") over the arctic, by painting roads or roofs white. The second approach, then, relies on the inhomogeneities in nature to minimize the impact without influencing the actual emissions.

A third approach would be to use natural or industrial processes to clean out the carbon dioxide from the atmosphere ex post. This approach would rely on the possibility that removing the carbon from the air after it is there is cheaper than refraining from putting the carbon in the atmosphere in the first place. Two possibilities here are simply growing trees and locking the carbon in the trees, or removing the carbon from the air by an industrial process.¹

To avoid the image of science fiction, we have initially limited control strategies to those clearly feasible--reductions in demand and substitution in supply (asterisked in Table 2). Because we cannot include the complete cycle at the present time, we must confine ourselves to a simple and unsatisfactory way of setting controls. The control strategy investigated in the present paper is to set an upper limit on the atmospheric concentration of carbon dioxide. Thus, in the present paper we describe the technological aspects of the model, and estimate the optimal response to arbitrary standards, as well as the differences between controlled and uncontrolled programs. It is hoped that in a future report, the methodo-

¹Many of the technological ideas mentioned above were developed in conjunction with C. Marchetti of IIASA. For a thoughtful essay on climatic engineering, see Kellogg and Schneider [1974]. See also Marchetti [1975].

logical and empirical steps necessary for setting optimal standards, as well as questions of implementation, will be treated, but these are outside the scope of the present paper.

In terms of the full cycle illustrated in Figure 4, we consider the sequence only as far as the arrow A ; this part of the cycle is relatively well understood, and we therefore are dealing with relatively minor levels of uncertainty. If progress can be made on the more difficult and important questions involved with the incorporation of the rest of the cycle, shown as B in Figure 4, then we can employ a more satisfactory procedure of setting standards.

The second problem of controlling carbon dioxide is implementation on a decentralized level. The theory of competitive markets shows how, in the absence of externalities, relative prices will be equal to relative marginal private and social costs and the allocation of resources is efficient (if not just). It should be emphasized that because of the externalities relative prices are no longer equal to relative social costs under competition, and there are no market or political mechanisms which ensure that the efficient allocation of resources (including the proper level of control on externalities) will be chosen. The procedure in the present paper will estimate an efficient way of allocating energy resources so as to satisfy the carbon dioxide constraint. To implement this efficient path means, implicitly, putting a positive price on emissions of carbon into the atmosphere. In the real world, the policy can take the form either of taxing carbon emissions, or of physical controls (like rationing). In an efficient solution the two are interchangeable in principle; in practice, the use of taxes is much simpler because the taxes tend to be much more uniform than the quantities. We therefore

will concentrate on "carbon taxes" as a way of implementing the global policy on a decentralized, individual level.

There is yet one final complication. We are analyzing the effects of carbon dioxide under the assumption that no other variables are changing. It may well be, however, that other variables--such as atmospheric dust or man-made heat--will either reinforce or offset the effects of carbon dioxide. If such interaction occurs, the conclusions will probably be quite different. On the other hand, once a model similar to that presented here for carbon dioxide is worked out for the other variables, the task of evaluating the overall optimum is straightforward.

III. Dynamics of the Carbon Dioxide Cycle

1. Sources of Carbon Dioxide

Keeling has recently described quite carefully the origins of man-made carbon dioxide.¹ Approximately 98 percent of industrial carbon dioxide originates in the energy sector, although of this about 5 percent ends up in non-energy uses (in asphalt, bitumen, lubricants, etc.). The other two percent of the industrial source is cement production. Table 3 gives the conversion factors for deriving the emissions of carbon dioxide from the consumption of fossil fuels, as well as the assumed conversion factors for non-fossil technologies.

The balance of production of natural carbon dioxide is more complicated and will be discussed in the next section.

2. Diffusion of Atmospheric Carbon Dioxide

Once carbon dioxide enters the atmosphere, the process of diffusion and into the ultimate reservoirs begins. Compared with most atmospheric pollutants, this process is extremely slow. Thus according to Keeling [1973], man's activities have added 17.9% to the atmospheric carbon dioxide over the period 1860 to 1969; of this approximately 10%, or 65% of the total added, remains in the atmosphere. A more recent study by Baes et al. [1976] suggest that 55% remains airborne.

An obvious but unanswered question is where the rest of the carbon dioxide has gone, and whether the division between atmosphere and other reservoirs will continue to be in the same proportion in the future as in the past.

¹Keeling [1973].

TABLE 3
Emission Factors for Carbon Dioxide

	Carbon fraction in fuel by weight	Fraction of fuel oxidized	Conversion factor (tons carbon per ton fuel)	Carbon content (10 ⁹ tons carbon per 10 ¹⁵ btu)
Coal and lignite	0.70	0.99	0.693	0.0279
Crude petroleum	0.84	0.915	0.769	0.0239
Natural gas	n.a.	0.97	n.a.	0.0144
Electrolytic hydrogen	0	n.a.	0	0
Nuclear energy	0	n.a.	0	0
Solar	0	n.a.	0	0

Source: For fossil fuels, from Keeling [1973], pp. 191, 180, 181, 178. The conversion factors (from Keeling) are 12,400 btu/lb for coal and lignite, 19,00 btu/lb for petroleum, and 1,030 btu per cu ft for natural gas.

n.a. = not applicable.

Note: For nuclear, solar and electrolytic hydrogen, it is assumed that the capital equipment is produced without cement or fossil fuels. If this assumption was incorrect, the figure would be a small fraction (one twentieth to one thousandth) of the figures for fossil fuels. Also, note that synthetic fuels (liquified and gasified coal) are charged for the full carbon content of the original fuel since the carbon losses are air-borne. Finally, it is assumed that the hydrogen fuels used for transportation are not converted to hydrocarbon fuels (as for example in methanol).

In what follows we will use a seven-layer well-mixed reservoir system, following the work of Keeling and Machta. Figure 7 shows the major reservoirs and flows which will be discussed in what follows. Several of the reservoir masses and flows are relatively well-agreed upon at the present (see the discussion in Bolin [1975]). For example, the masses of atmospheric and oceanic carbon, as well as the transfers within the atmosphere and between the atmosphere and the mixed, upper layer of the oceans is not the source of much disagreement. It is pretty well agreed that the concentrations in the atmosphere and the mixed layer of the oceans account for about 60% of the industrial carbon dioxide. The major mystery, however, is whether the remaining 40% has gone into the biosphere or into the deep ocean. From what is generally known about the age of the deep ocean, not much more than 5% of the industrial carbon dioxide would be in the deep oceans at present (see Bolin [1975], p. 232), but assigning the remaining 35% to an increase in the biosphere is more than most would accept. Some, particularly Oeschger [1974], have argued that carbon dioxide enters the deep ocean through turbulent diffusion, and from this argues that the very high "biosphere growth seems not necessary but evidence for exclusion is insufficient." This conclusion is, however, not generally accepted (see particularly Fairhall [1972]).

In what follows, we will adhere fairly closely to the seven-level model proposed and used by Machta ([1972], revised in Machta and Telegados [1975]), a model which is intermediate between the extreme views about the role of deep ocean and biosphere. In the sensitivity analysis to be presented in further work, we will test to see how the conclusions differ with alternative views about the relative importance of the deep oceans and the biosphere. In general, however, the split of the residual

FIGURE 7. The marginal first order transfer process between the seven reservoirs of carbon dioxide. The λ are the transfer coefficients, indicating what fraction of the mass of one reservoir is transferred to the second reservoir per year. The figures give the estimated amount of carbon (in metric tonnes) in each reservoir in pre-industrial times.

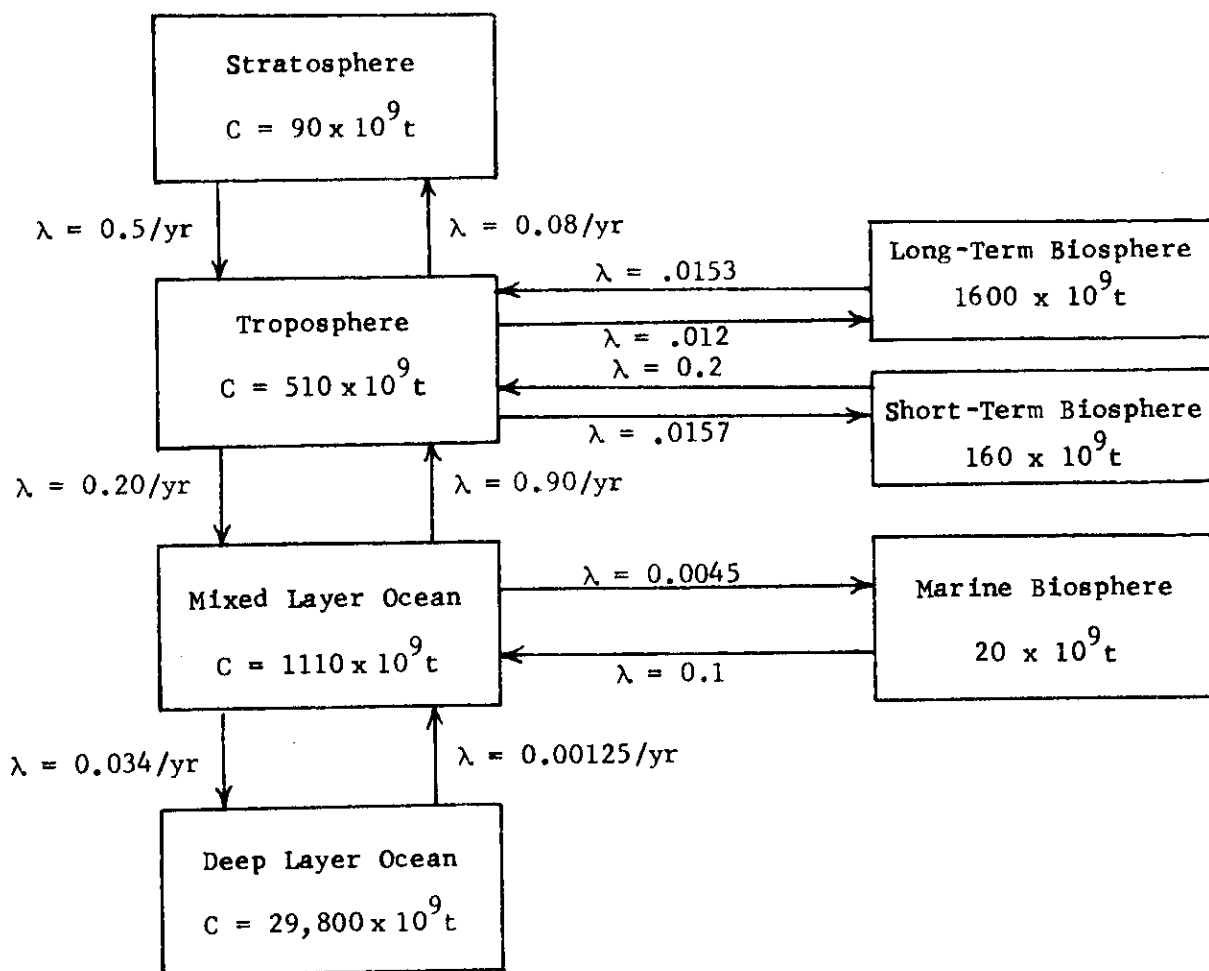

Sources: Machta [1972] as updated in Machta and Telegados [1974], p. 696. Exceptions are the biomass estimates, from Baes *et al.* [1976], and the transfer coefficients in the oceans, discussed in the text. Note that the biosphere transfer coefficients shown are equal to the biosphere-uptake elasticity (η) times the average or observed transfer coefficients, and that it is assumed that the buffer coefficient (b) is 10.

has very important long-run implications for carbon dioxide control strategies (see Section VI.4 below).

The current work follows early quantitative models in assuming that all reservoirs are well-mixed and representing the diffusion or transfer of the carbon dioxide as a first order exchange process. The system of equations is thereby linear and easily incorporated in a mathematical programming framework. The first-order exchange process assumes that a fixed fraction per period of the contents of one reservoir transfers to another reservoir. Keeling [1973a] describes a more complicated non-linear model in which the ability of non-atmospheric sinks to absorb carbon dioxide declines as the total mass increases. This non-linearity affects especially the buffering factor (mentioned below), but increasing ocean temperature also reduces the ocean's ability to hold carbon. The assumption of linearity is a practical step, immensely helping the computation, but it is recognized that this is a drastic simplification of the underlying processes.

In the original Machta model, it was assumed that a second process relates the exchange between the atmosphere and oceans and the biosphere via primary productions or gross photosynthesis. More specifically, Machta assumed that a mass of carbon equal to photosynthesis is transferred from a reservoir to biosphere every year; that after a specified number of years the carbon simply returns to the reservoir by the process of decay. This assumption has been slightly modified in what follows by assuming that the process of decay is exponential rather than "one-hoss-shay," but with the same mean residence time. This assumption simplifies the process by changing the dynamic structure into a first order Markov pro-

cess rather than a mixed Markov-difference equation system.

The simplified carbon cycle is laid out in Figure 7, along with the transfer rates and contents. There are seven reservoirs in the model: two atmospheric strata (stratosphere and troposphere); two ocean layers (mixed ocean--down to 60 meters--and deep layer); and three biospheres (short-term land biosphere, long-term land biosphere, and marine biosphere).

In estimating the transfer coefficients in Figure 7, most are from extraneous information rather than direct estimates. The two coefficients relating to the transfer between the troposphere and the mixed layer, however, are estimated empirically by Machta using residence times from bomb-C¹⁴; according to his results (see his Table 2), the coefficients are relatively well-determined.

Three further points are worth mentioning. First, the estimates of the levels of the biomass and the time delays are due to the ecologists Woodwell, Olson, and Leith, as cited in Machta [1972], as updated in Baes et al. [1976]. The masses are known to only a factor of two to four. The major difficulty is what follows, however, is to estimate the effect of increased carbon dioxide concentrations on the rate of photosynthesis, a factor which we call η = elasticity of carbon dioxide uptake in plants with respect to the carbon concentrations (or $= d[\log \text{uptake}]/d[\log C \text{ concentration}]$). Several authors suggest that for carbon dioxide limited biomass, the increase of photosynthesis will be 5% for each 10% increase in carbon dioxide concentration. Woodwell and Olson estimate that roughly half of the land biosphere is carbon dioxide limited, so that an increase of 10% in atmospheric carbon dioxide is assumed to lead to an increase of 2.5% in gross photosynthesis, for $\eta = 0.25$. Keeling [1973a] indicates that assimilation of carbon dioxide is proportional to the

logarithm of its concentration, leading to $\eta = .28$ at current concentrations. These estimates are highly uncertain, but they will be retained for the present paper.

A second factor is the problem of buffering of the carbon molecules in the sea. Machta writes as follows (p. 126):

[Consider] the dependence of the partial pressure of carbon dioxide on other carbon molecules in the sea. Thus the fractional change in the carbon dioxide pressure is ten times greater than the fractional change in the inorganic carbon content of the mixed layer. This buffering effect has the following consequences: Assume for the sake of explanation that the mixed layer has a carbon content equal to that of the atmosphere and that the mixed layer does not exchange with the deep ocean. Then if 11 units of carbon dioxide are added to the atmosphere, the equilibrium partition between air and mixed layer will not be 5.5 in air and 5.5 in ocean but rather 10 in air and only 1 in oceans. This 10 to 1 ratio may, according to Keeling, be as low as 6 to 1 or as high as 14 to 1. (p. 228)

The effect of the buffering factor, \underline{b} , is that the "effective mass" of organic carbon is \underline{b} times greater in the oceans than in the atmosphere; to incorporate this factor, it is necessary to modify the ratio of the exchange coefficients multiplied by \underline{b} .¹

¹The Machta model multiplies the coefficient $\lambda_{M \rightarrow T}$ (the transfer from the mixed layer to the troposphere) by \underline{b} , resulting in some cases of a coefficient greater than unity. In our interpretation, we set the coefficient $\lambda_{M \rightarrow T}$ at 0.9, and then $\lambda_{T \rightarrow M}$ is equal to $0.9 \times 1110/510 \times \underline{b}$, so if $\underline{b} = 10$, $\lambda_{T \rightarrow M} = .196$. It should be noted that the transfer coefficients for the Machta model between atmosphere and mixed oceans appear much larger than others. Partly this is a result of the definition of the reservoirs (the troposphere rather than the atmosphere) and partly because the mixed layer is quite shallow (only 60 meters). In any case, in the time frame we are discussing, the difference for the control strategy of a five year rather than a two year mean residence time is insignificant. See also Bolin [1975] for a recent survey.

It should be noted that the reservoir of sedimentary deposits has been omitted from the model; this is simply because the rate of fossilization is four orders of magnitude less than the rate of photosynthesis. According to Bolin [1975], the rate of sedimentation is in the order of 10^9 tonnes carbon/year, which is approximately one part per 1,000 of the biomass. This rate is too small to effect the results within the time frame we are considering. In addition, the "pH-stat" of the oceans--which over long periods converts dissolved carbons to clays--is omitted (see MacIntyre [1970]).

When all the pieces of the model were put together, and the concentrations of the various reservoirs calculated, it became clear that the mystery of the missing 35 percent alluded to above was unsolved, since the atmospheric concentrations were too high. As the greatest controversy and most likely source was the deep oceans, we increased the transfer from mixed to deep layer by changing the average age (or residence time) from 1700 to 800 years--a figure well within the range of estimates. This correction seems to be consistent with recent data on aging (see Stuiver and Broecker [1975]), as well as the calculations of Oeschger [1975].

The technical operation of the model can be easily shown. Let d_{ij} be the transfer coefficient per year from reservoir i to reservoir j ; let the one-year transfer matrix $\begin{bmatrix} d_{ij} \\ 7 \end{bmatrix}$ be represented by D . Note that D is a Markov matrix, so $\sum_{j=1}^7 d_{ij} = 1$. Further, let the mass of a given reservoir in year t be denoted by $M_i(t)$, $i = 1, \dots, 7$; with the column vector $M(t)$.

Our basic diffusion equation is that:

$$M_i(t) = \sum_{j=1}^7 d_{ji} M_j(t-1), \quad i = 1, \dots, 7,$$

or in matrix form

$$M(t) = D'M(t-1)$$

where D' is the transpose of D .

Table 4 shows the one year transfer matrix, while Table 5 shows the 100 year transfer matrix. These indicate how a one-shot injection into a given stratum is distributed over the indicated period. The figures for non-atmospheric strata will be interesting in later discussions.

Table 6 shows a more detailed set of distribution coefficients for atmospheric emissions. The top shows, as do Tables 4 and 5, the distribution for one shot injections, while the bottom half shows how the emissions are distributed for continuous emissions for the given time period. The estimates for the fraction of the CO_2 remaining in the atmosphere are slightly higher than in most other models for the short run--with 77 percent remaining in the atmosphere after one year; or 62 percent after 20. While this figure exceeds some estimates (see Machta [1972], PSAC [1965], Keeling [1973]), but it should be noted that these are marginal residences for a twenty-five year period whereas other figures cited refer to the average residence time of all man-made carbon dioxide. Note further that the asymptotic fraction of the total carbon dioxide remaining in the atmosphere is 15 percent, a figure well below the usual assumption in simple calculations.¹

¹ Further results with sensitivity analysis on the transfer coefficients will be available soon.

TABLE 4

One Year Distribution Matrix, $\underline{b} = 10$, $\eta = 0.25$

	T	S	M	D	SB	LB	MB
T	.688	.088	.196	--	.016	.012	--
S	.500	.500	--	--	--	--	--
M	.900	--	.062	.034	--	--	.001
D	--	--	.00125	.99875	--	--	--
SB	.200	--	--	--	.800	--	--
LB	.015	--	--	--	--	.985	--
MB	--	--	.100	--	--	--	.900

Notes on matrix: The distribution matrix is a probability matrix whose rows each sum to one. The entries indicate the fraction of the mass of that basin on the left hand column which flows per unit time period to the basin on the top row. The basins are denoted as follows:

T = Troposphere

S = Stratosphere

M = Mixed layer of the oceans (0 to 60 meters deep)

D = Deep layer of the oceans (deeper than 60 meters)

SB = Short-term biosphere

LB = Long-term biosphere

MB = Marine biosphere

TABLE 5

100 Year Distribution Matrix, $\underline{b} = 10$, $\eta = .25$

	T	S	M	D	SB	LB	MB
T	.301	.055	.065	.289	.027	.262	.001
S	.303	.055	.066	.285	.027	.262	.001
M	.300	.053	.064	.310	.025	.254	.001
D	.050	.009	.011	.905	.004	.022	.000
SB	.314	.056	.067	.280	.027	.262	.001
LB	.310	.054	.065	.157	.026	.390	.001
MB	.314	.056	.067	.291	.027	.252	.001

Notes on matrix: The distribution matrix is a probability matrix whose rows each sum to one. The entries indicate the fraction of the mass of that basin on the left hand column which flows per unit time period to the basin on the top row. The basins are denoted as follows:

T = Troposphere

S = Stratosphere

M = Mixed layer of the oceans (0 to 60 meters deep)

D = Deep layer of the oceans (deeper than 60 meters)

SB = Short-term biosphere

LB = Long-term biosphere

MB = Marine biosphere

TABLE 6
Coefficients for Distribution of CO₂ in Lower Atmosphere

Years	<u>One-Shot Injections</u>			
	Atmosphere	Mixed Ocean	Deep Ocean	Biosphere
1	.77	.20	.00	.03
10	.70	.13	.04	.13
20	.62	.11	.08	.18
50	.47	.09	.18	.26
100	.36	.06	.29	.28
300	.23	.04	.53	.20
∞	.15	.03	.72	.11
	<u>Continuous Injections</u>			
1	.77	.20	.00	.03
10	.77	.13	.02	.07
20	.72	.12	.04	.12
50	.61	.11	.09	.18
100	.51	.09	.16	.23
300	.36	.06	.34	.24
∞	.15	.03	.72	.11

IV. Limits on Carbon Dioxide Concentrations

In the present paper, we do not attempt to examine terribly carefully the question of appropriate standards; this question must be deferred for future work in which the effects on climate and agriculture, as well as the lags, are carefully scrutinized. Rather, we attempt in the current report to examine the response of the system to arbitrarily given standards.

Unfortunately, it is difficult to consider what even an appropriate set of standards might be. First, although considerable concern has been expressed about future trends in carbon dioxide concentration, the author knows of no attempts to suggest what might be approximate standards, or limits to set in a planning framework. Second, it is clear that, except in the most extreme cases, standards cannot be determined in vacuo; rather they must be determined within a general framework of society's preferences and the technology.

In brief, the considerations for standards are as follows: The emissions of carbon dioxide in themselves are insignificant: carbon dioxide is not toxic to man until concentrations in the order of 20,000 parts per million (ppm) are reached, compared to current atmospheric concentrations of around 330 ppm. Thus the effect of carbon dioxide on man occurs predominantly through modifications of climate and ecology.

As a first approximation, it seems reasonable to argue that the climatic effects of carbon dioxide should be kept within the normal range of long-term climatic variation. According to most sources the range of variation between distinct climatic regimes is in the order of $\pm 5^{\circ}\text{C}$, and at the present time the global climate is at the high end of this range. If there were global temperatures more than 2 or 3°C above the

current average temperature, this would take the climate outside of the range of observations which have been made over the last several hundred thousand years. Within a stable climatic regime, such as the current interglacial, a range of variation of 2°C is the normal variation: thus in the last 100 years a range of mean temperature has been 0.6°C . On the other hand, studies of the effects of carbon dioxide on global temperature cited above indicate that a doubling in concentration would probably lead to an increase in surface temperature of between 0.6 and 2.9°C depending on whether the full ice-albedo feedback is included (see p. 8 above).¹

As a first approximation, we assume that a doubling of the atmospheric concentration of carbon dioxide is a reasonable standard to impose at the present stage of knowledge. First, according to the estimates of the effect on temperature, the ensuing temperature changes would be somewhere between one times and four times the change observed over the last century. Although we do not know exactly what the effect is, we are probably not changing the climate more than has been associated with the normal random variations of the last few thousand years, although we are raising the mean. Second, note that the effects will be temporary, not permanent, in that after the use of fossil fuels ceases the atmospheric concentration will decrease over time as mixing of the atmospheric carbon into the ocean takes place; roughly speaking, the asymptotic level of carbon dioxide will be about one-fourth of the maximum concentration. Thus unless irreversible changes occur, the climate would have only a transient period of warming followed by a cooling back to where it started.

¹For sources of the observations in this paragraph, see Lamb [1972] or Understanding Climatic Change [1975].

The issue of irreversibility is discussed by Lorentz ([1968] and [1970]), in which he suggests that the climate may be an "intransitive" system. Models such as Sellar [1974], Schneider and Gal-Chen [1973] suggest intransitivity for cooling, but not for warming of the earth. Finally, it must be emphasized that the emissions are not irreversible. It is possible to remove carbon dioxide from the atmosphere by running combustion in reverse; thus if it appears that we have underestimated the magnitude of the effects of carbon dioxide, it is possible to engage in efforts to reduce the concentrations, or at least to offset the effects of the increased concentrations.

Thus as a first approximation to the setting of standards, we assume that doubling of atmospheric concentration of carbon dioxide is a reasonable upper limit. We will also test the sensitivity of our results to limits by imposing limits of fifty percent and two hundred percent increase. Table 7 shows the cases examined in the standards model.

The standards proposed here, as well as the reasoning behind it, are extremely tentative. It must be emphasized that the process of setting standards used in this section is deeply unsatisfactory, both from an empirical point of view and from a theoretical point of view. We can only justify the standards set here as rough guesses; we are not certain that we have even judged the direction of the desired movement in carbon dioxide correctly, to say nothing of the absolute levels.

TABLE 7

Cases Examined in Standards Model

<u>Case</u>	<u>Standard</u>
	Limit on increase of atmospheric carbon dioxide, as percent of original concentration:
I. Uncontrolled Case	No limits (e.g., infinite)
II. Least Stringent Control Case	Limited to 200 percent increase over pre- industrial concentration
III. Base Control Case	Limited to 100 percent increase over pre- industrial concentration
IV. Most Stringent Control Case	Limited to 50 percent increase over pre- industrial concentration

V. The Energy Model

The energy model used for the investigation is fully described elsewhere and only a brief sketch will be given here.¹ The energy model is a linear programming model designed to simulate the functioning of a competitive market for energy products. The basic building blocks of the model are the preference functions and the technology.

1. The preference function is drawn from market demand data. The energy sector is divided into four sectors (electricity, industry, residential, and transportation); and each of the four sectors has separate estimates for the market demand curves. These curves are functions of population, per capita income, and relative prices. Note that the demand functions are sensitive to the price of energy products.

2. The technology or constraint set is derived from engineering and geological data on the different resources available, and the costs of extraction, transportation, and conversion. Under the assumption that the economy is directed either by central planners who efficiently allocate resources, or is organized into competitive firms supplying the various goods and services, the technology can then be translated into the usual competitive supply curves for different products.

The procedure then involves maximizing the preference function subject to the technology constraints. This problem is solved by a medium-sized linear programming algorithm, involving 551 constraints and 2991 variables. The output of the solution is given in terms of the activity levels (e.g. the production of coal or oil in a given period), as well

¹For a description of an early version of the model, see Nordhaus [1973]. A more recent version, with minor changes in the model structure, is available in mimeo (Nordhaus [1976]), and a fuller monograph will be forthcoming.

as the value of the dual variables (to be interpreted as shadow prices, opportunity costs, or, in a competitive framework, as competitive prices).

Formally, the problem can be written as follows. The energy model attempts to simulate the market allocation process. Thus, let U_{it} be the present value of the marginal utility, in terms of income, of good i in year t ; c_{it} be the present value of the cost of good i in year t , both discounted at 10 percent, and let x_{it} be the level of activity. Under suitable assumptions (see Samuelson [1966a]) a market allocation can be described by the mathematical programming problem:

$$(1) \quad \underset{\{x_{it}\}}{\text{maximize}} \quad \sum_{t=1}^T \sum_{i=1}^n [U_{it} - c_{it}] x_{it},$$

subject to resource constraints,

$$(2) \quad \sum_{t=1}^T \sum_{i=1}^n A_{ij} x_{it} \leq \bar{R}_j, \quad j = 1, \dots, m,$$

where A_{ij} is the content of scarce resource j per unit activity of good i , and \bar{R}_j is the amount of scarce resource R_j which is available.

The goods x_{it} are composed of different energy goods (6 different fuels used in 4 different sectors), for 2 different regions of the world (U.S. and the rest of the world), for 10 time periods of 20 years each. The scarce resources are two grades (high and low cost) of 6 different kinds of resources (petroleum, natural gas, coal, shales, natural uranium and thorium), available in each of the two regions. Unlike the earlier versions, the model incorporates substantial constraints on new technologies, adaptation of demands, and upper bounds on rates of growth.

The macroeconomic assumptions are basically that growth in GNP per capita will continue, but at a diminishing rate over the next 200 years; that population will also slow to reach a world level of 10 billion

in 2050; and that the rate of technological change (equal to the rate of growth of per capita GNP) will be the same in all sectors. Finally the discount rate on goods is taken to be 10 percent per annum, although this may well differ from the discount rate on utility.

The model just described has been in operation for about four years and has been used for a number of diverse problems. In this paper we will describe how the technique can be used to describe the future buildup of atmospheric contaminants over the medium and long run, as well as to estimate the costs, benefits, and timing of controls.

To implement this change, we need to introduce the three factors discussed in the last section: emissions, diffusion, and standards. To do this we add a second block of constraints into the linear program shown in equations (1) and (2) above. First, let $\gamma(\ell\ell, i)$ be the emissions per unit activity x_{it} into stratum $\ell\ell$ (in 10^9 tons carbon per 10^{15} btu). Then total emissions into stratum $\ell\ell$ in a given period, $E(\ell\ell, t)$ are

$$(3) \quad E(\ell\ell, t) = \sum_{i=1}^n \gamma(\ell\ell, i)x_{it} \quad , \quad \ell\ell = 1, \dots, L \quad , \quad t = 1, \dots, T .$$

Next denote $M(\ell\ell, t)$ as the total mass of CO_2 (in 10^9 tons C) in a given stratum, and $d(i, j)$ as the transition probabilities of moving from stratum i to stratum j . From the basic diffusion equations we have

$$(4) \quad M(\ell\ell, t) = \sum_{i=1}^L d(i, \ell\ell)M(i, t-1) + E(\ell\ell, t) \quad , \quad \ell\ell = 1, \dots, L \quad , \quad t = 1, \dots, T .$$

Finally, we impose standards on the energy sector that the total mass in a given stratum should not exceed $St(\ell\ell)$:

$$(5) \quad M(\ell\ell, t) \leq St(\ell\ell) , \quad t = 1, \dots, T .$$

To implement the controls, we used to add equation set (3), (4), and (5) to our original problem in (1) and (2). A complete map of the problem is given in Table 8 below. For computational simplicity we have constrained the concentration of tropospheric carbon dioxide, thereby introducing a computational inaccuracy in the order of 0.5 percent.

It should be noted that the optimization framework makes computation of a single run relatively expensive, precluding extensive experimentation and sensitivity analysis.

TABLE 8

Map of Linear Programming Problem

CONSTRAINTS

	ACTIVITIES			
	$x(i, j, jj, k, l, n)$	$xp(k, l, m, n)$	$xc(m, mm, n)$	$e(ll, n)$
$r(i, j, jj)$	Extraction	0	0	0
$p(k, l, n)$	Extraction	Conversion	0	0
$c(m, l, n)$	0	Conversion	Consumption	0
$e(ll, n)$	Emissions from Extraction	Emissions from Conversion	Emissions from Consumption	Total Emission
$m(ll, n)$	0	0	0	Mass Equations
Objective Function	Cost	Cost	Utility	

Variables:

x = extraction
 xp = processing
 xc = consumption
 e = emission

Constraints:

r = resource availability
 p = processing balance equations
 c = consumption balance equations
 e = emissions identity
 m = mass diffusion equation

Subscripts:

i = country of resource
 j = kind of resource
 jj = grade of resource
 k = fuel
 l = country of consumption
 ll = environmental stratum
 m = demand category
 mm = step in demand function
 n = time period

VI. Results of the Standards Model

In this section we will present the results of the runs with the "standards model" outlined in the last section. Recall that there are four different runs; they differ only in the standards imposed on the concentration of carbon dioxide. In what follows we will be interested in the general timing of the control program, in the problem of feasibility of the control program, and finally on the costs of controls and the effect on energy prices.

1. The Question of Feasibility

The first question to investigate is whether the standards paths are feasible. This question is answered automatically by the linear programming routine, but it is of independent importance.

The question of feasibility rests on the existence of activities which meet the demand constraints with relatively low levels of carbon dioxide emissions. In reality, any non-fossil fuel energy source (fission, fusion, solar, or geothermal) will be an option for meeting the carbon dioxide constraint since the non-fossil fuels have no significant carbon dioxide emissions. In the program discussed above, we consider both solar and nuclear fission as an alternative to fossil fuels, but the results would be identical for any of the other non-fossil fuels (fusion, geothermal) with the same cost structure.

In the program outlined above, it would be possible to set arbitrarily low carbon dioxide standards because the energy system can adapt to these by simply shifting the mix from fossil to nuclear fuels. It should be noted, however, that the model used here overemphasizes the degree of malleability of the system in ignoring historically built

capital equipment as well as overestimating the speed of reactions. To be realistic, it is probable that it would take at least 25 years to phase out carbon-based fuels even with a crash effort, so this places an outside limit on the feasibility of carbon dioxide limitation. Aside from this lag, and assuming the technological relations are correctly specified, however, there are no significant problems of limiting carbon dioxide emissions from a technical point of view.

2. Comparison of Uncontrolled and Controlled Programs: Quantities

The next question concerns the comparison of the uncontrolled path and the controlled paths. In the program discussed above, we have divided the period into 10 periods, each with 20 years. The most important question is the timing of the limitations on carbon dioxide emissions. Table 9 and Figures 8 and 9 show the paths of emissions and concentrations for carbon dioxide in the atmosphere for each of the four paths.

The first point to note is that the uncontrolled path does lead to significant changes in the level of atmospheric carbon dioxide. According to the projection of the model, atmospheric concentrations in the uncontrolled path rise by a factor of five (3137/616) over the entire period. This increase is far above what we assume to be the limit of a doubling of the carbon dioxide concentration. Put differently, it appears that if serious problems are likely to occur when the level of carbon dioxide has doubled or more, then the uncontrolled path appears to be heading for the danger zone. It appears that the doubling will come around 2040.

It is interesting to compare the calculated path with current estimates of emissions and concentration. Table 10 shows these figures. As

TABLE 9

Industrial Carbon Dioxide Emissions and Concentration
Predicted from Model

Industrial Carbon Dioxide Emission Rate (10^9 tons carbon/yr.)	Pre- Industrial	Actual 1974	Projected					
			<u>1980</u>	<u>2000</u>	<u>2020</u>	<u>2040</u>	<u>2100</u>	<u>2160</u>
1. Uncontrolled	{ 0.0	5.0	6.9	10.7	18.3	40.1	64.0	0.0
2. 200% Increase			6.9	10.7	18.3	38.1	36.6	14.7
3. 100% Increase			6.9	10.7	16.6	16.1	4.9	3.7
4. 50% Increase			6.9	8.9	4.0	2.4	1.6	1.3
Total Carbon Dioxide Concentration in Atmosphere (10^9 tons carbon)			<u>1990</u>	<u>2010</u>	<u>2030</u>	<u>2050</u>	<u>2070</u>	<u>2170</u>
1. Uncontrolled	{ 616	702	768	896	1115	1615	3137	2355
2. 200% Increase			768	896	1115	1586	1951	1953
3. 100% Increase			768	896	1088	1244	1239	1237
4. 50% Increase			768	869	883	879	871	868

Note: CO_2 in the atmosphere in 1970 is distributed over time according to the distribution model and then added to the calculated amount. This procedure introduces some inaccuracy in the optimization procedure.

Emissions of
carbon dioxide,
billions of tonnes
per year, carbon
weight

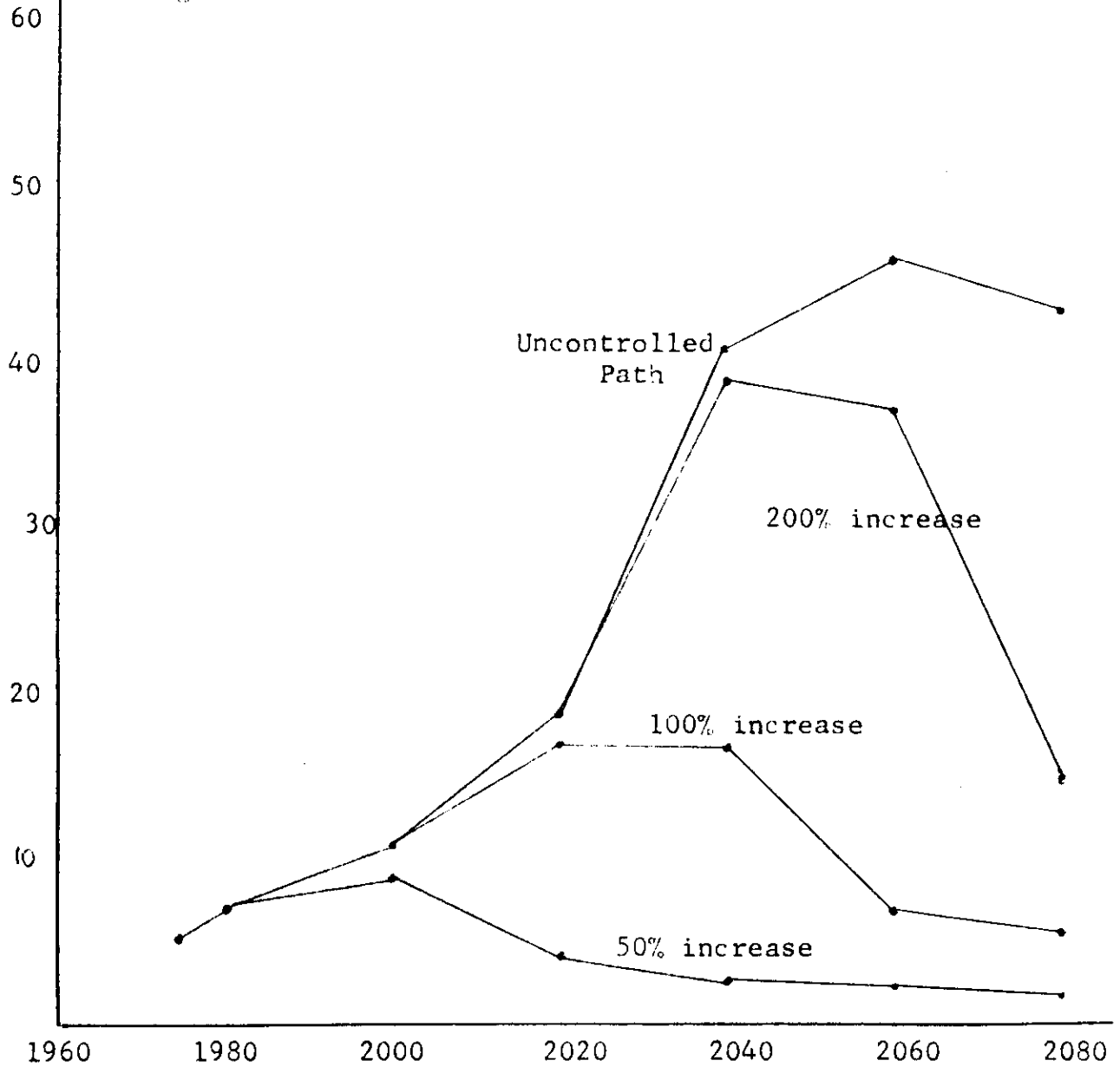

Figure 8. Calculated emissions of carbon dioxide along alternative paths, 1960-2080, with actual emissions for period up to 1974. Figures in billions of metric tonnes, carbon weight.

Total Concentration of Industrial
Carbon Dioxide and in
Three Reservoirs,
Billions of Metric Tonnes

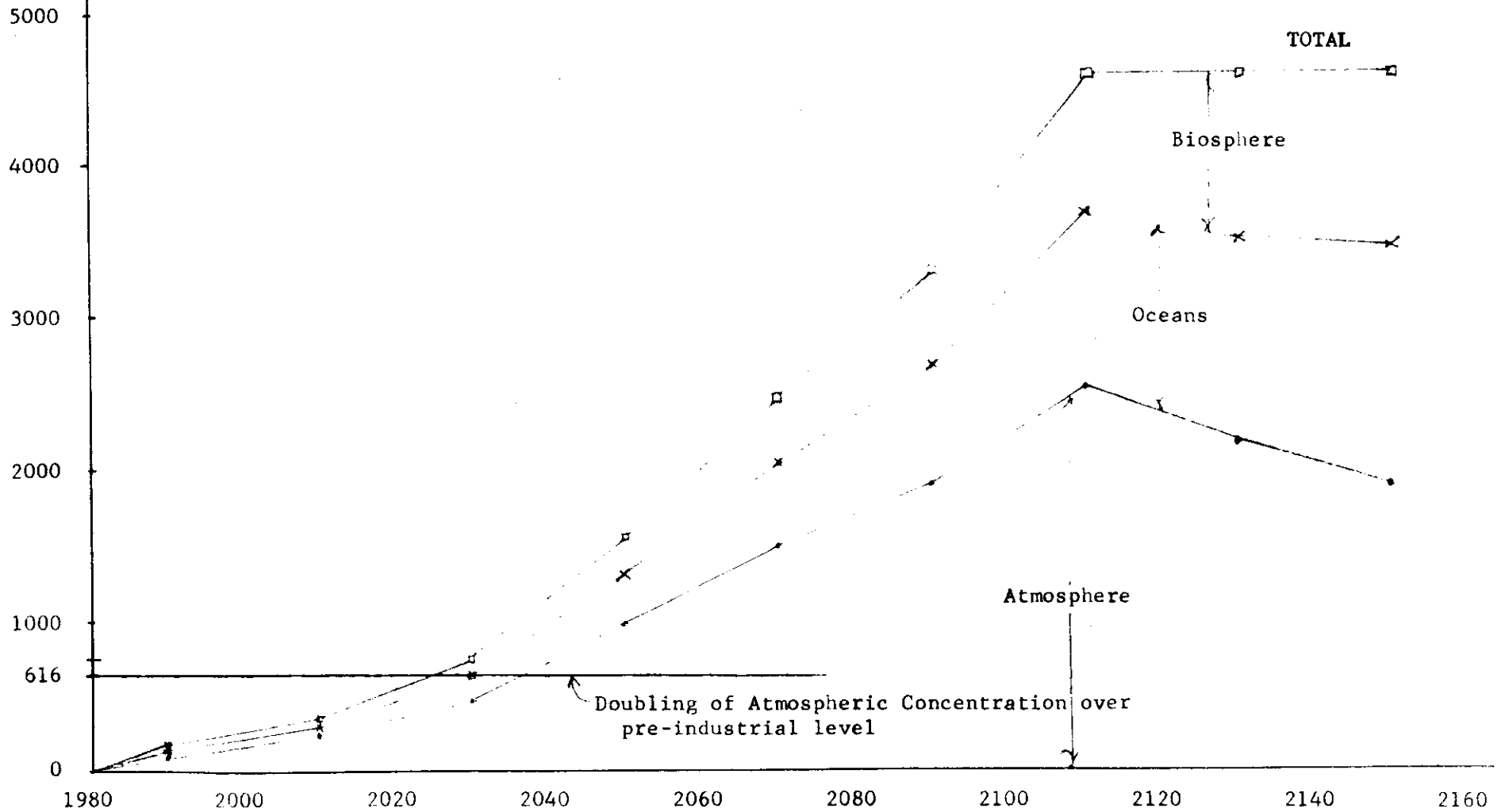

Figure 9. Distribution of Industrial Carbon Dioxide over time by Reservoir, Uncontrolled Path

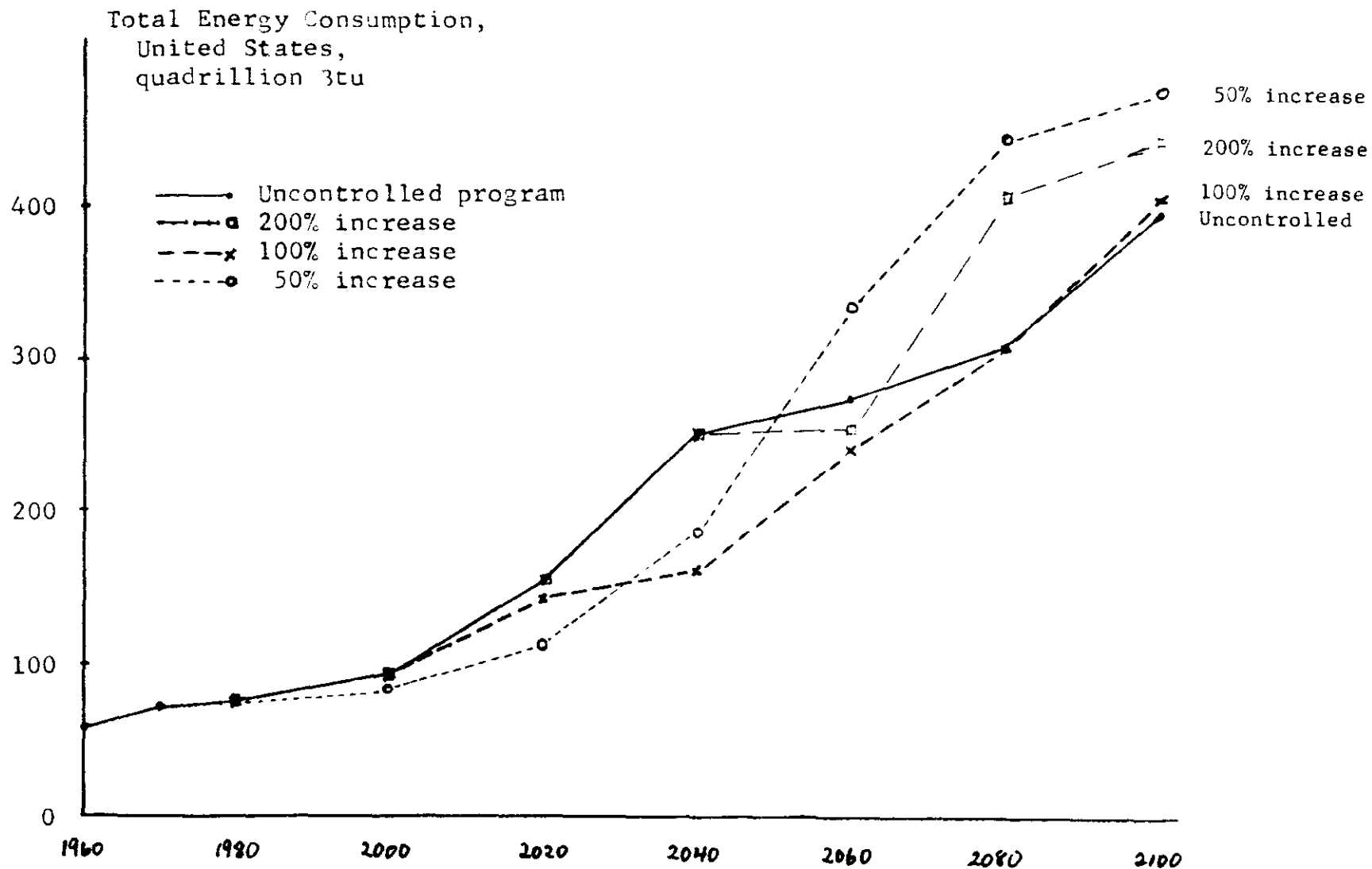

Figure 10. Total energy consumption (gross energy inputs), United States, for alternative control programs. Figures for 1960-75 are actual, those for 1980-2100 are calculated in alternative control programs.

TABLE 10

Comparison of Uncontrolled Model Projections with Observed Values, 1974 and Other Projections, 2000

	1974		2000		
	Actual	Calculated from Model	Calculated from Model	Estimated by: Machta Baes <u>et al.</u>	
Atmospheric Concentration					
In 10^9 tons carbon	702.	702.	832.	846.	702.-862.
In part per million	321.	321.	381.	387.	321.-394.
Emission					
In 10^9 tons carbon	5.0	4.89	10.7	11.4	

Actual from Baes et al. [1976]. Calculated for 1974 use actual values for the 1970 and interpolate geometrically. Figures for Machta from Machta and Telegados [1974], p. 695, and Baes et al. [1976], p. 39.

is shown, the emissions agree very well with concentrations and figures. Projections for the future are also shown, and these are in the general range of other projections.

The second important point, and perhaps the most surprising one, is that the optimal path does not differ from the uncontrolled path for the first periods (that is to say the periods from 1970 to 1990) and that abatement measures become necessary only in the second period (1990 to 2010) for the most stringent controls and the third period (2010 to 2030) for the other two programs. Put differently, according to the cost schedules assumed in the model, it does not pay to curtail carbon dioxide emissions until nearly the time when the limit is reached; and for the three cases examined this time comes in the 1990-2010 period or the 2010-2030 period. This point is important, for it implies that there is still a comfortable amount of time to continue research and to consider plans for implementation of carbon dioxide control if it is deemed necessary.

It is important to understand where the abatement measures would take place in an efficient program. Recall that in the model, there are five fuels (oil, natural gas, coal, electricity, and hydrogen) and these are used in four sectors (electricity, industry, residential, and transport). How will the mix of fuels to the different industries change? Also note that since demand is responsive to price in the model, it is possible that the level of final demand change in those sectors which are supplied by carbon-intensive fuels.

Table 11 indicates in a rough way the changes in the input mix sector over time. We have shown the fraction of the inputs which are carbon based (i.e. fossil-fuels): This aggregates over the different

TABLE 11

Fraction of Energy Inputs Which Are Carbon-Based (Fossil Fuels),
by Sector and Period, United States in Efficient Path

20 year period centered on:	SECTOR			
	Electricity	Industry	Residential	Transport
1980				
Uncontrolled	100%	100%	100%	100%
200% Increase	100%	100%	100%	100%
100% Increase	100%	100%	100%	100%
50% Increase	100%	100%	100%	100%
2000				
Uncontrolled	73%	100%	100%	100%
200% Increase	78%	100%	100%	100%
100% Increase	78%	100%	100%	100%
50% Increase	73%	100%	100%	100%
2020				
Uncontrolled	13%	100%	87%	100%
200% Increase	6%	100%	87%	100%
100% Increase	0	100%	75%	100%
50% Increase	0	100%	0	100%
2040				
Uncontrolled	0	100%	66%	100%
200% Increase	4%	100%	0	88%
100% Increase	0	93%	0	0
50% Increase	0	44%	0	0
2060				
Uncontrolled	0	100%	0	100%
200% Increase	0	40%	0	0
100% Increase	0	15%	0	0
50% Increase	0	6%	0	0
2080				
Uncontrolled	0	7%	0	0
200% Increase	0	11%	0	0
100% Increase	0	0	0	0
50% Increase	0	0	0	0

fossil fuels but gives the best overall measure of the impact of control programs by industry. Interestingly enough, the chief difference lies in the industrial sector. Here, coal-based fuels are used essentially throughout the period under consideration in an uncontrolled program; as can be seen, however, starting in the fourth period, and especially in the fifth, heavy curtailment of fossil-fuels is necessary, especially in the most stringent control programs. The same general pattern appears in the residential sector in the third and fourth period, and in transport in the fourth period. On the other hand, relatively little change is introduced in the electricity sector, as the transition to non-fossil fuels is essentially completed before the carbon dioxide constraints become binding.

The program calculates, but we have not shown, the effect of the constraints on demand. Recall that demand is sensitive to price, so that it is possible that demand will be curtailed in order to meet the carbon constraints. At first blush, it is plausible to argue that since carbon emissions must be reduced by 80 percent from the uncontrolled path, demand must also be reduced by 80 percent. In fact, this naive view would be almost completely wrong: almost no changes in the demand pattern occur, and almost all the reaction comes about as a result of supply side adjustments. Put differently, the efficient way to restrict emissions is to change the composition of production away from carbon-based fuels rather than to reduce consumption. The reason for this will become apparent when we examine the effects of prices. Figure 10 shows for the United States the effect of the carbon dioxide controls on gross energy inputs (usually called "energy consumption"). The striking result

is that very little change in end use or energy inputs is required to meet the carbon dioxide constraints.

3. Effects of Control Programs on Temperature and Sea Level

The reason for the control program is that we are concerned about the effects of concentrations on temperature, with one of the more significant effects of the temperature increase being the level of the oceans. Figure 11 shows the estimated effect of different control programs on global mean temperature. The relationship assumed in this figure is that temperature is a function of the logarithm of CO₂ concentration, and that a doubling of CO₂ leads to an increase of 2° C.

To estimate the level of the oceans is a most hazardous exercise, given that there is at present no generally agreed-upon statistical relation between global temperature and sea level. A very rough estimate in the Appendix indicates that an order of magnitude estimate was that an increase of global temperature of one degree C would lead to a rise of the level of the oceans by approximately $2.4 \pm (1.0)$ millimeters per year. Figure 12 uses this estimate along with the estimates of global temperature increase in Figure 11 to indicate an order of-magnitude estimate of the effect of different CO₂ on the level of the oceans. It is clear that in none of the cases does the effect appear catastrophic, but the long-run implications of the uncontrolled path (losing 0.8 meters to the oceans by the end of the 21st century) are uncomfortable, whereas the controlled paths lead to much less rapid rises of coastline.

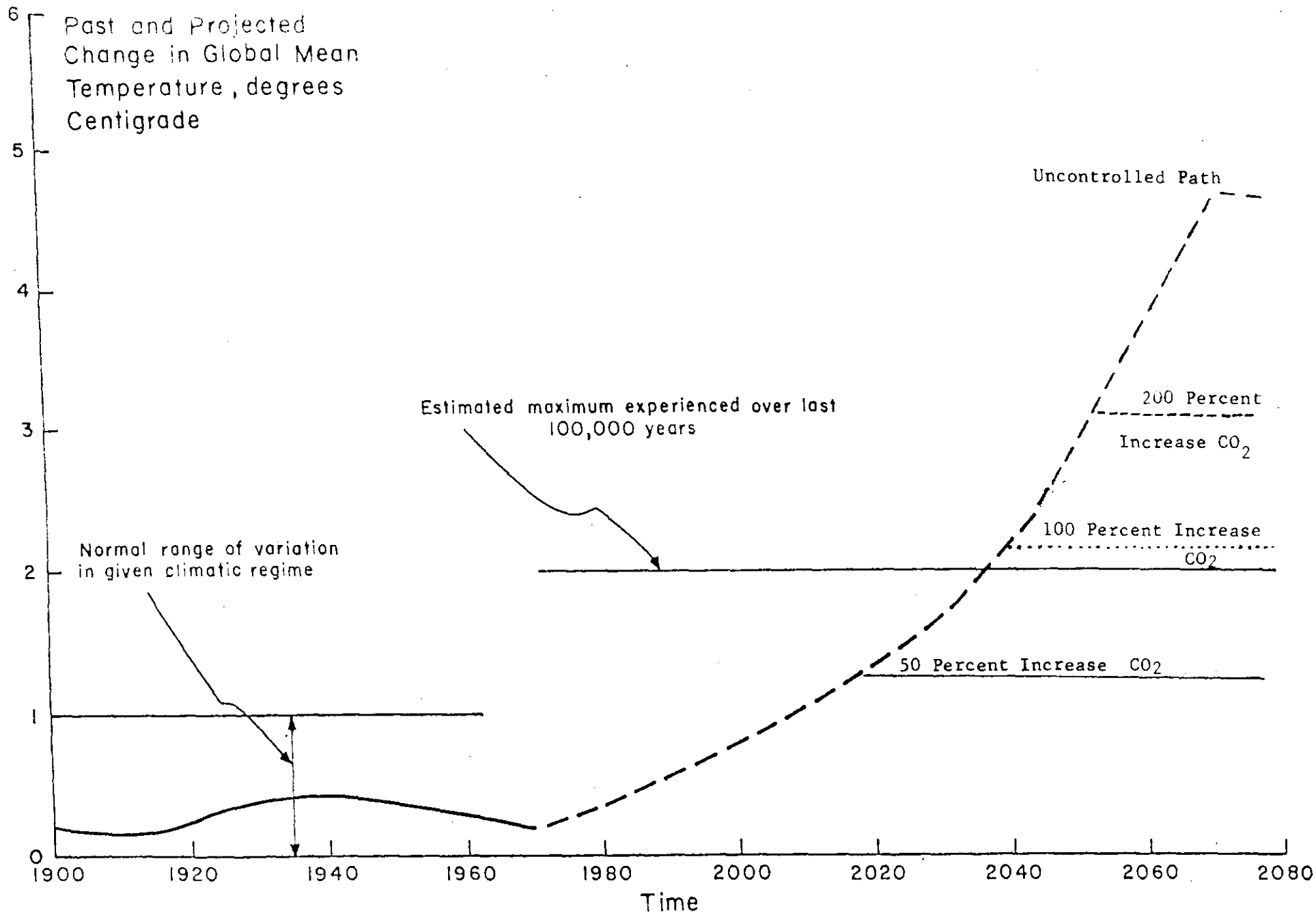

Figure 11. Past and projected change in global mean temperature, relative to 1880-84 mean. Solid curve up to 1970 is actual temperature. Curves from 1970 on are projections using 1970 as a base and adding the estimated increase due to carbon dioxide. Assumed relationship is that temperature responds as a linear function of the logarithm of carbon dioxide concentration, with a doubling of carbon dioxide leading to a 2° C increase in temperature.

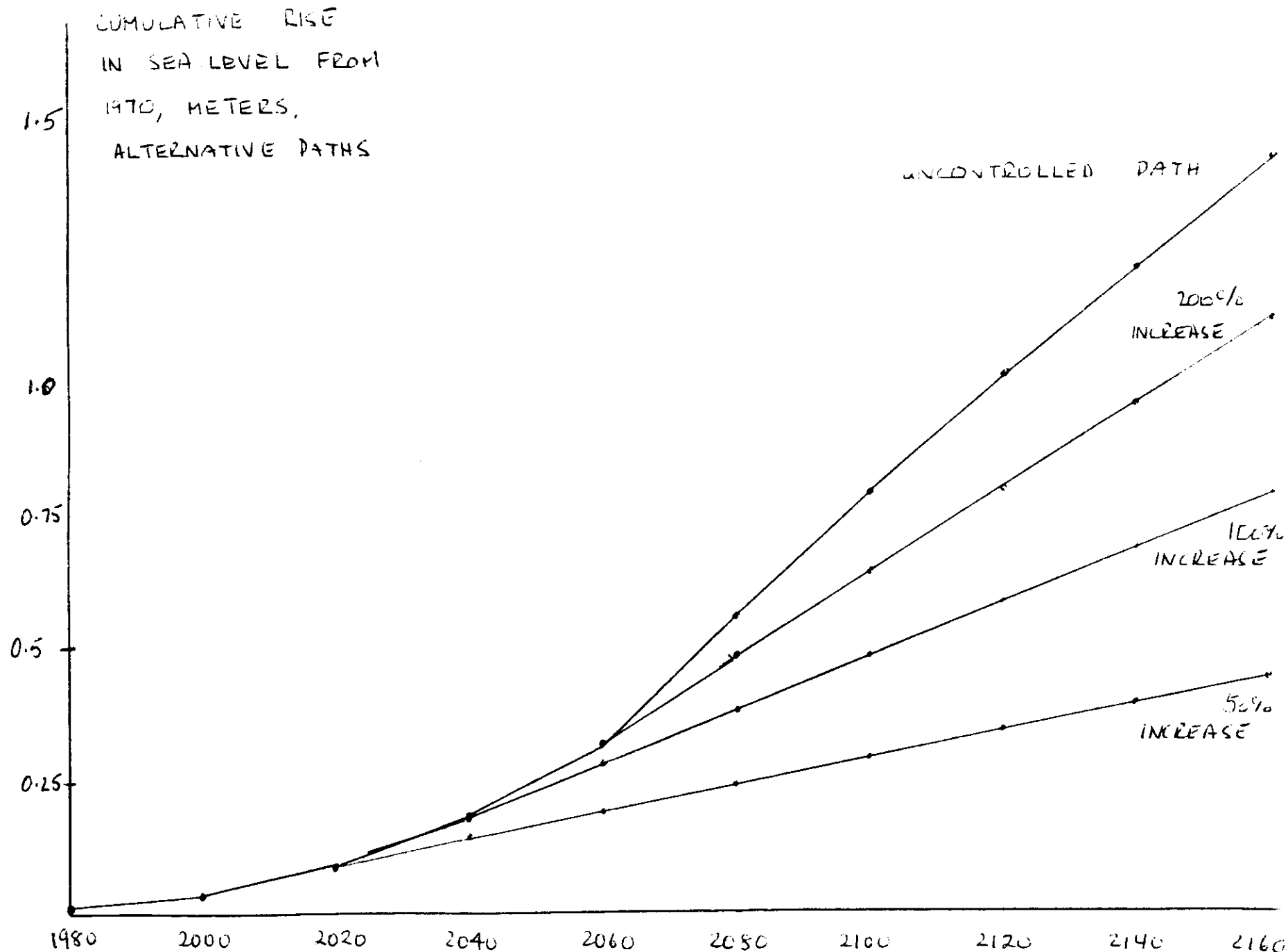

Figure 12. Estimates of the effect of temperature increase on the level of oceans for alternative paths of carbon dioxide concentrations. All calculations assume no rise in coastlines with no change in carbon dioxide concentrations. Estimate of temperature increase is shown in Figure 11. Effect on sea level is assumed to be 2.4 millimeters per degree C per year (see Appendix for derivation).

4. Prices and Costs

In an optimization framework, as in an economy, constraints have their costs in terms of the objectives of the optimization. Recall that the control program takes the form of imposing upper bounds on the level of atmospheric concentrations; these are formally imposed as ten inequality constraints on the problem (one inequality for each time period). Associated with each of the constraints is a dual variable--sometimes called a shadow price--which in the optimal solution calculates the incremental amount that the constraint costs in terms of the objective function. Put differently, the shadow price indicates how much the objective function would increase if the constraint were relaxed one unit.

The most important shadow prices in the carbon dioxide optimization are the shadow prices on the carbon dioxide emissions constraints. The constraints are in terms of 10^9 metric tons of carbon in the troposphere, while the objective function is real income of consumers in 10^9 dollars of 1975 prices. This implies that the shadow price has the dimensions of dollars per ton of carbon dioxide emitted into the troposphere.

Table 9 gives the shadow prices for carbon emissions for the four programs during the 10 periods. First note that the uncontrolled program has shadow prices equal to zero, indicating that the constraint is not binding. Second, note that the prices per ton start very low (between \$0.01 and \$0.15 per ton carbon) and rise to a very high level of between \$130 a ton (1970 prices), by the end of the next century. These should be compared with the prices of carbon-based fuels, which are around \$25

TABLE 12

Shadow Prices on Carbon Dioxide Emissions
(1975 dollars per ton carbon)

	PROGRAM			
	I Uncontrolled	II 200% Increase	III 100% Increase	IV 50% Increase
1980	0.00	0.00	0.14	1.65
2000	0.00	0.07	1.02	12.90
2020	0.00	0.52	8.04	109.00
2040	0.00	4.07	67.90	123.60
2060	0.00	34.47	94.40	200.00
2080	0.00	42.00	94.40	200.00
2100	0.00	42.04	87.20	198.20
2120	0.00	41.91	87.10	198.50
2140	0.00	42.92	86.90	188.40
2160	0.00	40.93	95.10	95.10

a ton (carbon weight) of coal, \$100 a ton (carbon weight) for petroleum, and \$200 a ton (carbon weight) for natural gas. Roughly speaking, the shadow price only becomes significant in the second period for the most stringent path (path IV) and in the third and fourth period for the medium permissive paths, III and II respectively. Comparing Tables 9 and 12, we note, then, that the shadow prices are relatively low for periods when the concentration constraint is not binding and high in those cases where it is binding.

The carbon dioxide constraints play a leading role in the drama. Not only do they show the cost of a given constraint for the world economy as a whole; they also act as a medium for decentralizing the control strategy. It is essential for implementing a control strategy that the shadow prices on carbon emissions actually get built into prices that firms and consumers face. Without such an internalization of the climatic externality, it can hardly be expected that emissions will be reduced: by contrast, when coal prices double as a result of an emissions tax, we can expect substitution away from coal and its derivatives.

We may also ask what the effect of the carbon dioxide control program is on energy prices in general. These effects fall into two general categories: effects on factor prices--in particular royalties on scarce energy resources; and effects on product prices. Table 13 shows the results. Note that the major impact is on factor prices rather than product prices. For example, comparing the shadow prices of the most stringent with the uncontrolled case, note that petroleum and gas shadow prices fall considerably for the abundant non-U.S. resources, while coal and oil shale royalties fall to zero. By contrast, uranium royalties rise by an insignificant amount (about 0.1 percent) from the uncontrolled to the

TABLE 13
Effects of Carbon Dioxide Controls on Factor and Product Prices
(all prices in 1975 dollars)

	PROGRAM			
	I Uncontrolled	II 200% Increase	III 100% Increase	IV 50% Increase
FACTOR PRICES* (dollars per 10 ⁹ btu)				
Petroleum				
US	875.2	875.2	875.3	874.6
Row	1.5	1.5	1.5	0.0
Natural Gas				
US	1465.6	1465.6	1465.4	1459.9
Row	2.0	1.9	1.8	1.8
Coal				
US	1.3	1.0	0.0	0.0
Row	1.3	1.0	0.6	0.0
Shale				
US	12.9	12.8	12.4	0.0
Row	1.5	0.1	0.0	0.0
Uranium 235	0.29	0.29	0.29	0.29
US PRODUCT PRICES (dollars per 10 ⁶ btu delivered)				
Electricity				
1980	8.06	8.06	8.07	8.17
2020	7.60	7.60	7.60	7.60
2080	8.00	8.00	8.00	8.00
Industrial				
1980	1.96	1.96	1.96	2.02
2020	2.04	2.05	2.28	5.64
2080	5.90	5.57	5.72	6.06
Residential				
1980	6.38	6.38	6.38	6.40
2020	6.72	6.72	6.72	8.78
2080	9.17	9.17	9.17	9.17
Transport				
1980	29.06	29.06	29.08	29.28
2020	30.11	30.16	31.22	42.41
2080	37.90	46.06	46.06	46.06
Price Index (Equal weights, 1970 = 100)				
1980	1.00	1.00	1.00	1.01
2020	1.02	1.02	1.07	1.66
2080	1.68	1.71	1.73	1.78

*The factor price or "royalty" refers to the price of the resource in the ground, before exploration, drilling, or mining has occurred. Each category refers to the most economic grade of resource, except for petroleum and natural gas where they refer to the value of undrilled resource.

most stringent program.

Final product prices are shown in the bottom half of Table 13, giving the market prices (including distribution, taxes, and retail mark-ups where appropriate) for each of the four major sectors. In addition, the last set of figures gives an index of retail prices of energy goods, using equal weight for each of the four goods (note that this index does not use Btu weights). The uncontrolled path shows essentially no price increase from the 1980 levels for about 40 years, then a upturn in prices with the exhaustion of fossil fuels and the gradual penetration of non-fossil fuels late in the next century. The two less stringent control programs look very similar, with only very minor increases in prices (less than five percent higher than the uncontrolled path). The most stringent control path, however, shows a much more rapid increase in prices over the next fifty years; it is almost equivalent to having less fossil fuel resources in that the stringent control program drives up prices sufficiently to ensure more rapid penetration of non-fossil fuels.

A final question regarding shadow prices may appear bizarre: What are the shadow prices by environmental stratum? These refer to the shadow prices in the different regions of the earth (atmosphere, mixed ocean, deep ocean, etc.). Table 14 shows the shadow prices for each of the seven strata for the middle control strategy III, again in terms of prices per ton of carbon. These indicate the cost that would be incurred by an increase of one ton of the mass in a given stratum. Thus the price for carbon in the atmosphere in 2020 would be \$9, while in the long-term biosphere it would be \$3.

The important point about Table 14 is that there are only three economically interesting strata: the deep ocean, the long-term biosphere,

TABLE 14

Shadow Prices on Carbon Dioxide Concentrations by Stratum,
Control Program III
(dollars per ton carbon, 1975 prices)

	Period Centered on:			
	<u>1980</u>	<u>2000</u>	<u>2020</u>	<u>2100</u>
Troposphere	0.14	1.09	8.75	76.90
Stratosphere	0.14	1.09	8.75	76.90
Mixed Layer Ocean	0.14	1.06	8.53	73.50
Deep Layer Ocean	0.01	0.10	0.29	2.30
Short-Term Land Biosphere	0.14	1.14	9.10	78.70
Long-Term Land Biosphere	0.11	0.66	3.15	26.10
Marine Biosphere	0.14	1.08	8.69	75.00

and the rest of the strata. And the most interesting conclusion is that the cost of putting carbon into the deep ocean is only about one-thirtieth of the cost of putting it into the atmosphere. The reason for this anomaly is that by the time carbon is put into the deep ocean it is locked up there for about 1000 years. The price in the long-term biosphere is also significantly below, eventually about one-third, of the price in the other strata.

The implication of this finding about the shadow prices in different strata is of great importance for control programs. It says that on the margin, and taking 2020 as an example, it would be efficient to take emissions from the atmosphere and pump them into the deep oceans if this could be done for less than \$8 per ton. Similarly, if we could simply remove the carbon and put it into trees, which would decay, gradually adding the carbon back into the atmosphere, this would be worth a subsidy of up to \$6.50 per ton. These results can be used to evaluate processes, such as those proposed by Marchetti discussed above, to shortcircuit the distribution of carbon dioxide by placing it in the deep ocean or in trees. Given some preliminary estimates of the costs of these processes, it appears that they merit considerable attention. These results also suggest that such events as the Green Revolution, which dramatically increases yields in the short-term biosphere, would have essentially no effect in reducing the carbon dioxide problem: this result is simply due to the fact that the decay time of annual crops is so short that the total reduction of the atmospheric concentration of carbon dioxide is negligible.

We can also ask what the carbon dioxide constraints are costing in toto. Whereas the shadow prices give the cost on the margin, the overall cost can be evaluated by examining the attained value of the

objective function. As can be seen in Table 15, the control of carbon dioxide is not free--the medium control program 2 has discounted costs of \$87 billion in 1975 prices. On the other hand, the cost as a fraction of world GNP is likely to be insignificant, less than 0.5 percent in the most stringent case. This relatively small cost is consistent with the modest rise in energy prices shown in Table 13 above.

VII. Summary

We have investigated an efficient program for meeting certain carbon dioxide standards as in a long-term energy model. These indicate that for a range of standards (limited to between a 50 percent and a 200 percent increase in the atmospheric concentration) the program appears feasible. Moreover, it is a program which requires little change in the energy allocation for the first two 20 year periods, and only in the third period, centering on 2020, do modifications in the allocation take place. These modifications take the form of reducing the fossil fuel use in the non-electric sector, and replacing it with non-fossil fuels.

Moreover, it appears that the efficient programs have rather high implicit shadow prices on carbon dioxide emissions but that the total effect on energy prices and the total cost of providing the bundle of energy goods is relatively small. Whereas the estimated market price (including carbon tax) rises around 100 percent, the final price level for energy goods rises no more than five percent in the two less stringent programs investigated here.

Subject to the limitations of the model used here, then, we can be relatively optimistic about the technical feasibility of control of atmospheric carbon dioxide. If the control program is instituted in an

TABLE 15
 Cost of Carbon Dioxide Control Programs
 (billions of 1975 dollars)

	PATH			
	1 Uncontrolled	2 200% Increase	3 100% Increase	4 50% Increase
Discounted Total Cost, billions of 1975 dollars	\$0	\$4	\$87	\$540
Discounted Total Cost as Percent of Dis- counted World GNP	0%	0.004%	0.08%	0.48%

Note: Assumed rate of growth per annum of GNP are as follows:

	United States	Rest of World
1975-1990	3.7 %	6.5 %
1990-2010	2.7	5.1
2010-2035	2.1	3.7
2035 on	1.6	2.0

This gives a discounted value of world GNP of \$111.8 trillion.

orderly and timely way, the world energy system can adopt to controls of the magnitude examined here without serious dislocations. The central question for economists, climatologists, and other scientists remains: How costly are the projected changes in (or the uncertainties about) the climate likely to be, and therefore to what level of control should we aspire? And for students of politics, the question is: How can we reasonably hope to negotiate an international control strategy among the several nations with widely divergent interests?

APPENDIX. SEA LEVEL RESPONSE TO MEAN TEMPERATURE

At several places in the paper, reference is made to the response of the level of the oceans to global mean temperature. This effect of the carbon dioxide buildup (or other man-made emissions which also warm the globe) is universally recognized to be a most serious consequence.

The present author was unable to uncover any estimates of the effect of mean temperature on sea level in the published literature. For this reason, a very crude set of estimates was prepared using data on mean level of the oceans and mean temperatures. It should be emphasized that these estimates are banished to an appendix because the scientific quality of the approach is so dubious.

The underlying assumption is that the earth-climate represents a system in which there is a unique equilibrium relation between an external forcing function and the earth's climate--as in the Milankovitch theory. Moreover, to a first approximation, the level of the oceans is determined by the global mean temperature. The range of observations over the last 100,000 years is for a global mean temperature deviating from +2 to -10 degrees C from the current, and for ocean levels deviating from -100 to +10 meters from today's level. A very crude estimate, assuming global mean temperature is a suitable proxy for all climatic influences, would be approximately +10 meters per degree C.

There are two refinements which could be made. First, the relation is clearly nonlinear, since there are boundary conditions on both the high and low side. In what follows, however, it seemed fruitless to pursue nonlinearities since the lags are long and the data quite uncertain.

A second and critical consideration for our problem is that the response of oceans to temperature proceeds through melting or freezing of ice, and this process is extremely slow on the human scale. We have therefore attempted to estimate a linear lagged response of sea level to temperature.

The specification used is that there is at a point of time an equilibrium relationship between the global mean temperature, T_t , and the level of the oceans, S_t^* ; in addition, this is assumed to be a linear relationship within the range of observations of the last 15,000 years.

Thus

$$(1) \quad S_t^* = b_0 + b_1 T_t$$

where the S_t^* indicates the equilibrium level of the oceans. It is assumed that the rate of change in the level of the oceans responds with a first-order lag to the disequilibrium:

$$(2) \quad S_t - S_{t-1} = a(S_t^* - S_{t-1})$$

or

$$(3) \quad S_t = ab_0 + ab_1 T_t + (1-a)S_{t-1} + u_t$$

where u_t is a Markovian error term.

Using data from two different sources, we have estimated equation (3). The data are obtained by visual inspection and refer to mean temperature and sea level for 1000 year periods for Source 1 and 2500 year periods for Source 2--starting at the present and going back approximately 15,000 years. Source 1 is drawn from Understanding Climate Change [1975], Appendix A; and Source 2 is from Lamb [1975], pp. 186, 187 and 192. The

dimensions are S in [meters], T in [degrees C]. Therefore b_0 has dimension [meters], b_1 has dimension [meters/degree C]; and a has dimension [1/(1000 or 2500 years)]. The temperature data are generally not global means but refer to selected stations. For this reason, the coefficients may differ when applied to the global mean, but it is unlikely that the error is greater than 25 percent.

TABLE A-1. Estimates of the Response of Sea-Level to Mean Temperature

Source	Time Step in Observation (years) (1)	Regression Results				Asymptotic Rise in Sea Level (meters/°C) (6)	Short-Run Time Temperature Effect, μ (mm per °C per year for)			
		ab_0 (2)	ab_1 (3)	$1-a$ (4)	$\frac{-2}{R}$ (5)		50% of Rise, Years (7)	1 Year (8)	100 Years (9)	1000 Years (10)
1	1000	0.6 (.59)	1.89 (.093)	.626 (.093)	0.96	5.0	1500	2.4	2.4	1.9
2	2500	5.2 (1.11)	4.32 (.104)	.536 (.104)	0.97	9.3	2800	2.3	2.3	2.0

Note: Figures under coefficients are estimated coefficients, while figures in parentheses are standard errors of coefficients. R^2 is corrected for degrees of freedom.

The results of the regression are shown in Table A-1. These were estimated using least squares with a correction for first-order autocorrelation of residuals. The estimate of the mean lag in the two equations is somewhat inconsistent, with one set of data indicating that one-half the response occurs in about 1500 years, while the other indicates that one-half occurs in about 2800 years. The estimates of the asymptotic response

of such a linear model are also different for the two sources, with one source showing a response of 5.0 and the other 9.3 meters per degree C. These estimates are consistent with the order of magnitude estimate suggested on p. 71 above.

For the purposes of the present paper, however, the short-run response is the most important, and this is indicated in columns (8) through (10). The sources give almost exactly the same estimate for the "short run" response of sea level to temperature changes, with the effect being 230 to 240 millimeters per degree C sustained for 100 years, and from 1900 millimeters to 2000 millimeters per degree C sustained for 1000 years.*

Given the long delay in the response, it is appropriate to use the short run effects--coefficient μ --as the appropriate estimate for calculating the effect of CO_2 changes on the levels of the oceans. These indicate that the effect is about 2.4 millimeters per year per degree C. Given the general quality of the data and estimates, I would place a judgmental standard error on this of approximately 1.0 millimeters per year per degree C. This is the estimate that appears in the text.

*The response is obtained by first noting that $(1 - \lambda^\theta) = 1 - a$, where λ = the one-year response and θ = Time Step. The short run coefficient, μ , is then calculated so that $\mu/(1 - \lambda) = ab_1/(1 - \lambda^\theta)$.

REFERENCES

- Baes, et al. [1976]. C.F. Baes, H. E. Goeller, J. S. Olson, and R. M. Rotty. Baes, et al., "The Global Carbon Dioxide Problem," Oak Ridge National Laboratory, May 1976.
- Bolin [1975]. Bert Bolin, "A Critical Appraisal of Models for the Carbon Cycle," Appendix 8, GARP [1975], pp. 225-235.
- Bryson [1974]. Reid A. Bryson, "A Perspective on Climatic Change," Science, 184, 17 May 1974, pp. 753-760.
- Budyko [1972]. M. Budyko, "The Future Climate," Transactions of American Geophysical Union, 53, 1972, pp. 868-874.
- Budyko [1974]. M. Budyko, Climate and Life, Academic Press, New York and London, 1974, chapters 3-5, 9.
- Fairhall [1972]. A. W. Fairhall, "Accumulation of Fossil CO₂ in the Atmosphere and the Sea," Nature, Vol. 245, No. 5419, ²September 7, 1973, pp. 20-23.
- GARP [1975]. The Physical Basis of Climate and Climatic Modelling, World Meteorological Organization, GARP Publications Series, No. 16, April 1975.
- Granger [1966]. C. W. J. Granger, "The Typical Spectral Shape of an Economic Variable," Econometrica, Vol. 34, No. 1, January 1966, pp. 150-160.
- Hardin [1960]. Garnett Hardin, "The Tragedy of the Commons," Science, December 1968, pp. 1243-1248.
- Herman and Browning [1975]. Benjamin M. Herman and Samuel R. Browning, "The Effect of Aerosols on the Earth--Atmosphere Albedo," Journal of the Atmosp. Sciences, July 1975, pp. 1430-1445.
- Keeling [1973]. Charles D. Keeling, "Industrial Production of Carbon Dioxide from Fossil Fuels and Limestone," Tellus, 25, 1973, pp. 174-198.
- Keeling [1973a]. Charles D. Keeling, "The Carbon Dioxide Cycle," in N. Rasool, ed., Chemistry of the Lower Atmosphere, Plenum Press, New York, pp. 251-329.
- Kellogg, et al. [1975]. W. W. Kellogg, J. A. Coakly, Jr., and G. W. Grams, "Effects of Anthropogenic Aerosols on the Global Climate," WMO [1975], pp. 323-330.
- Kellogg and Schneider [1974]. W. W. Kellogg and S. H. Schneider, "Climate Stabilization," Science, 1974.

- Kutzbach and Bryson [1975]. J. E. Kutzbach and R. A. Bryson, "Variance Spectrum of Holocene Climatic Fluctuations in the North Atlantic Sector," in WMO [1975].
- Lamb [1972]. H. H. Lamb, Climate: Present, Past, Future, Vol. I, Mellmen and Co., Ltd., London, 1972.
- Lorenz [1968]. E. N. Lorenz, "Climatic Determinism," in Causes of Climatic Change, Meteorol. Monogr., 8, 1-3, 1968.
- Lorenz [1970]. E. N. Lorenz, "Climatic Change as a Mathematical Problem," Journal of Applied Meteorology, 9, 325-329.
- Machta [1972]. Lester Machta, "The Role of the Oceans and Biosphere in the Carbon Dioxide Cycle," Nobel Symposium 20, pp. 121-145.
- MacIntyre [1970]. Ferren MacIntyre, "Why the Sea is Salt," Scientific American, 223 [1970], pp. 104-115.
- Machta and Telegados [1974]. L. Machta and G. Telegados, "Climate Forecasting," in W. N. Hess, Weather and Climate Modification, New York, 1974.
- Manabe and Wetherald [1967]. S. Manabe and T. T. Wetherald, "Thermal Equilibrium of the Atmosphere with a Given Distribution of Relative Humidity," Journal of Atmospheric Sciences, vol. 24, 1967, pp. 241-259.
- Manabe and Wetherald [1975]. S. Manabe and T. T. Wetherald, "The Effect of Doubling CO₂ Concentration on the Climate of a General Circulation Model," Journal of Atmospheric Sciences, January 1975, 32, pp. 3-15.
- Marchetti [1976]. Cesare Marchetti, "On Geoengineering and the CO₂ Problem," IIASA Research Memorandum RM-76-17, March 1976.
- Matthews, et al. [1971]. W. H. Matthews, W. W. Kellogg and G. D. Robinson, Man's Impact on the Climate, MIT Press, Cambridge, USA, 1971.
- National Academy of Sciences [1975]. Understanding Climatic Change, A Program for Action, Washington, D.C., 1975.
- NCAR [1974]. National Center for Atmospheric Research, Atmospheric Implications of Energy Alternatives, UCAR Forum, October 1974.
- NCAR [1975]. National Center for Atmospheric Research, Atmospheric Implications of Energy Alternatives, Boulder, USA, February 1975.
- Newson [1975]. R. L. Newson, Nature, Vol. 241, January 5, 1973, p. 39.
- Nordhaus [1973]. W. D. Nordhaus, "The Allocation of Energy Resources," B.P.E.A., 1973:4, pp. 529-570.
- Nordhaus [1975]. W. D. Nordhaus, "Can We Control Carbon Dioxide?" IIASA Working Paper.

- Oeschger, Siegenthaler, Schotterer and Gugelmann [1975]. H. Oeschger, U. Siegenthaler, U. Schotterer and A. Gugelmann, "A Box Diffusion Model to Study the Carbon Dioxide Exchange in Nature," Tellus, 27, p. 168.
- Pigou [1960]. A. C. Pigou, The Economics of Welfare, MacMillan, 1960, 4th edition.
- PSAC [1965]. President's Science Advisory Committee, Restoring the Quality of Our Environment, Report of the Environmental Pollution Panel, Washington: Government Printing Office, 1965.
- Samuelson [1966a]. P. A. Samuelson, "Market Mechanisms and Maximization," Collected Papers, Cambridge, Mass., pp. 425-492.
- Samuelson [1966b]. P. A. Samuelson, "The Pure Theory of Public Expenditures," Collected Papers, Cambridge, Mass., pp. 1223-1225.
- Schneider [1975]. S. H. Schneider, "On the Carbon Dioxide Climate Confusion," Journal of the Atmospheric Sciences, 32, 1975, pp. 2060-2066.
- Schneider [1976]. S. H. Schneider, The Genesis Strategy, Plenum Press, New York.
- Schneider and Gal-Chen [1973]. S. H. Schneider and T. Gal-Chen, "Numerical Experiments in Climate Stability," Journal of Geophysical Research, 78, pp. 6182-6194.
- Sellers [1974]. William D. Sellers, "A Reassessment of the Effect of CO₂ Variations on a Simple Global Climatic Model," Journal of Applied Meteorology, October 1974, pp. 831-833.
- Shotkin, Ludewig and Thompson [1975]. Louis M. Shotkin, Hans Ludewig and John F. Thompson, Jr., "Calculated Effects of Aerosols on Sunlight," Journal of Applied Meteorology, March 1975, pp. 189-193.
- Stuiver and Broecker [1975]. M. Stuiver and W. S. Broecker in WMO [1975]. WMO [1975].
- Untersteiner [1975]. N. Untersteiner, "Sea Ice and Ice Sheets and Their Role in Climatic Variations," in GARP [1975].
- Warshaw and Rapp [1972]. M. Warshaw and R. R. Rapp, R-908-ARPA.
- WMO [1975]. World Meteorological Organization, Proceedings of the WMO/IAMAP Symposium on Long Term Climatic Fluctuations, WMO No. 471, Geneva, 1975.

APPENDIX REFERENCES

- Lamb [1976]. H. H. Lamb, "The Earth's Changing Climate," 1976 Yearbook of Science and the Future, Encyclopaedia Britannica Inc., Chicago, pp. 180-195.
- Schofield and Thompson [1964]. J. C. Schofield and H. R. Thompson, New Zealand Journal of Geology and Geophysics, vol. 7, pp. 359-370.
- Understanding Climatic Change [1975]. National Academy of Sciences, Understanding Climatic Change: A Program for Action, Washington, D. C., 1975.